

Guidelines for Display Rules & Regulations

Contents

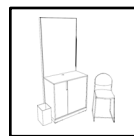

Kiosk

3

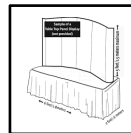

Tabletop

4

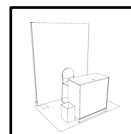

Mini Booth

5

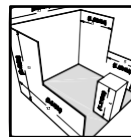

Linear and Corner Booth

6

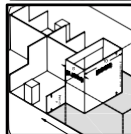

Peninsula Booth

8

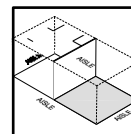

Split Island Booth

9

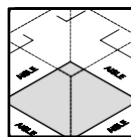

Island Booth

10

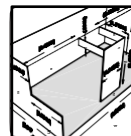

Extended Header Booth

11

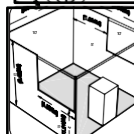

Other Important Considerations

12

Issues Common to All Booth Types

13-15

Guidelines for Display Rules and Regulations

- Responsibility of the exhibiting company to comply with SPIE rules and regulations
- Non-compliance may require modifications at the exhibitor's expense
- SPIE Exhibition Management reserves the right to pursue any action it deems necessary in the best interest of the exhibition and in fairness to all exhibitors
- All open or unfinished sides of the exhibit which may appear unsightly must be covered or the organizer will have them covered at the exhibitor's expense
- Any portion of the exhibit bordering another exhibitor's space must have the backside of the exhibit finished and not incorporate any identification signs, lettering or graphics
- Peninsula, Split Island and Island exhibits must have a finished back wall and be finished on all sides
- Items located in the exhibit space must be in good taste or will be removed at the discretion of the organizer

VIEW SPECIFIC BOOTH REGULATIONS

- [Kiosk displays](#)
- [Tabletop displays](#)
- [Mini Booths](#)
- [Linear and Corner Booths](#)
- [Peninsula Booths](#)
- [Split Island Booths](#)
- [Island](#)
- [Canopy and Ceiling Regulations](#)
- [Issues Common to all Booth types](#)

Kiosk

Kiosk exhibit space is a turnkey countertop package.

Dimensions and Use of Space

Kiosk exhibits are placed next to other exhibits with no dividing side rail.

Any space between kiosks is neutral area for access and must be kept clear.

No additional furnishing, electrical, floor standing AV, signs, etc, may be added to your display.

All equipment, including monitors, must fit within the dimensions of the cabinet top.

Included

- 8 feet high x 3 feet wide fabric backwall with graphics*
- Lockable cabinet (42 inches high x 36 inches wide x 20 inches deep) with graphics*
- One barstool
- Carpet
- Wastebasket
- 500 watt (5 amp) electrical outlet plus one power strip
- Installation and dismantle fees included

*Graphics are provided directly to the service contractor

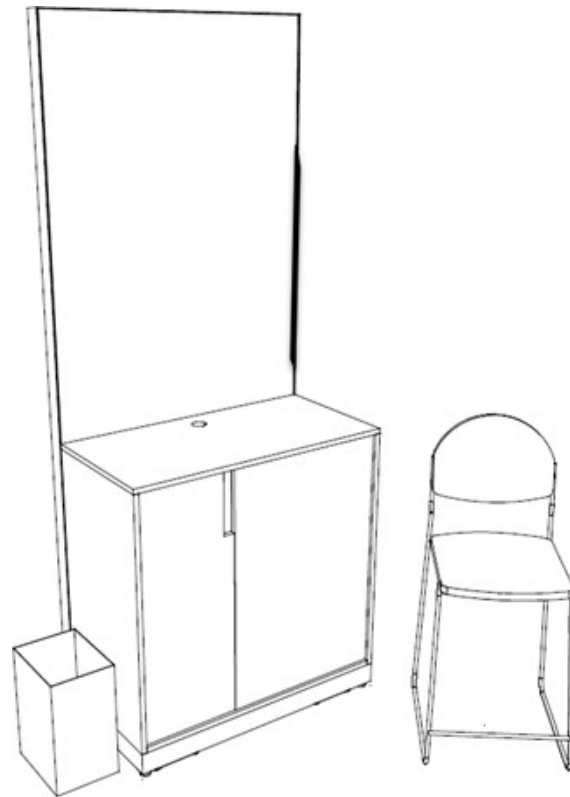

Tabletop

Tabletop exhibit space is a turnkey package with limited customization.

Dimensions and Use of Space

Tabletop exhibits are placed next to other exhibits with no dividing side rail.

Any space between tabletops is neutral area for access and must be kept clear.

All display items including monitors, graphics, literature racks, etc., must fit within the dimensions of the tabletop space.

Limit of ONE table per contracted tabletop space, 2 feet x 6 feet (.6m x 1.8m)

- Display space may not exceed 6 feet (1.8m) width
- Display materials are not allowed to be hung on back drape
- Tabletops are a package offering and furnishings may not be exchanged.

**NO HANGING FROM
BACK DRAPE**

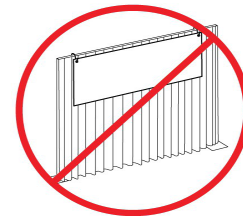

Included:

- One 2 feet x 6 feet (.6m x 1.8m) skirted display table
- Company identification sign
- 500 watt electrical outlet
- Two chairs
- Carpet
- Wastebasket



Each contracted tabletop space is limited to:

- 5 feet from the top of table - as shown above
- 6 feet width - no items outside the width of the table as shown above
- 5 feet depth (2 feet of which is taken up by table)

SPIE Exhibition Management reserves the right to remove any display that does not conform to tabletop display regulations.

Mini Booth

A Mini Booth is a turnkey booth package.

Dimensions and Use of Space

Each contracted mini booth is limited to:

- 8 feet height -- nothing may be attached to the backwall
- 6.5 feet width – no items outside the width of the backwall as shown below
- 5 feet deep – 2 feet of which is taken by the cabinet

Mini booths are placed next to other exhibits with no dividing side rail. No additional furnishing, electrical, floor standing AV, signs, etc, may be added to your display.

All equipment, including monitors, must fit within the dimensions of the cabinet top.

Included:

- 8 feet high x 6.5 feet wide fabric backwall with graphics*
- Lockable cabinet (42 inches high x 36 inches wide x 20 inches deep) with graphics*
- Two barstools
- Carpet
- Wastebasket
- 500 watt (5 amp) electrical outlet plus one power strip
- Installation and dismantle fees included

*Graphics are provided directly to the service contractor.

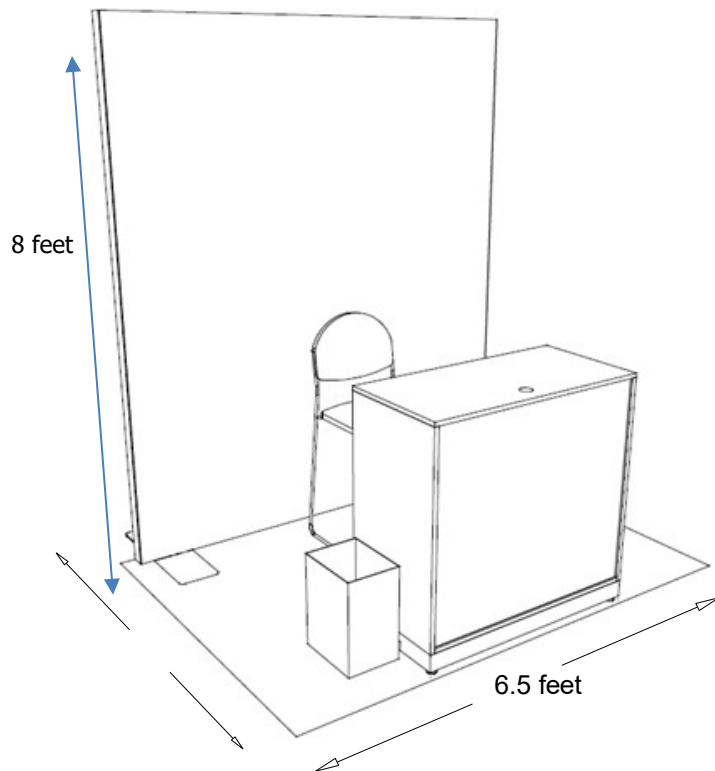

Line-of-Sight

Line-of-Sight display rules provide restrictions on certain areas of booths to allow attendees to view neighboring booths in their line of sight as they walk the floor. There are a variety of booth types, and each one is addressed below with specific insight on how to implement Line-of-Sight regulations.

Linear Booth

The ability to have products or services easily seen by attendees as they walk the aisles is essential to all exhibitors, and that is the basis for including a Linear Booth Line-of-Sight setback rule. Linear Booths, also called "in-line" booths, are generally arranged in a straight line and have neighboring exhibitors on their immediate right and left, leaving only one side exposed to the aisle.

Dimensions

For purposes of consistency and ease of layout and/or reconfiguration, floor plan design in increments of 10 feet (3.05m) has become the de facto standard in the United States. Therefore, unless constricted by space or other limitations, Linear Booths are most commonly 10 feet (3.05m) wide and 10 feet (3.05m) deep, i.e. 10 feet by 10 feet (3.05m by 3.05m). A maximum back wall height limitation of 8 feet (2.44m) generally specified to prevent display materials from imposing on neighboring exhibits behind the back wall.

Corner Booth

A Corner Booth is a Linear Booth at the end of a series of in-line booths with exposure to intersecting aisles on two sides. All other guidelines for Linear Booths apply.

Booth Use of Space

Regardless of the number of Linear Booths utilized, e.g. 10 feet by 20 feet, 10 feet by 30 feet, etc., display materials should be arranged in such a manner so as not to obstruct sight lines of neighboring exhibitors. The maximum height of 8 feet (2.44m) is allowed only in the rear half of the booth space, with a 4 feet (1.22m) height restriction imposed on all materials in the remaining space forward to the aisle. *Note: When three or more Linear Booths are used in combination as a single exhibit space, the 4 feet (1.22m) height limitation is applied only to that portion of exhibit space which is within 10 feet (3.05m) of an adjoining booth.* No solid side walls are allowed to extend beyond 5 feet (1.5m) from the back of booth.

Lighting:

Lighting, including gobos, should be directed to the inner confines of the booth space. Lighting should not project onto other exhibits or aisles. Additional materials may be required to defuse back-lit displays.

Included:

- 8 feet (2.4m) high x 10 feet (3.05m) wide black drape to define the back 'wall' of the booth
- 3 feet (.9m) high x 10 feet (3.05m) long black side rail drape to define the side 'walls' of the booth
- Company identification sign

NOT Included:

- Electricity or any utilities
- Any furnishings
- Carpet

Additional Guidelines:

- Exhibitors are required to adhere to Union Guidelines
- Exhibitors are required to carpet their booth space when venue is not carpeted
- No overhead hanging signs are allowed
- Nothing may be pinned or adhered to the drape

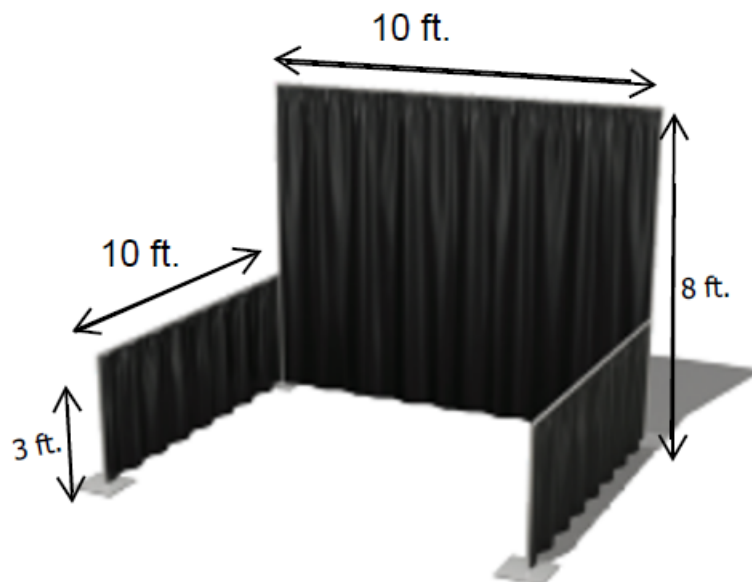

Peninsula Booth

A Peninsula Booth is exposed to aisles on three sides and comprised of a minimum of four booths. There are two types of Peninsula Booths: (a) one which backs to Linear Booths, and (b) one which backs to another Peninsula Booth and is referred to as a "Split Island Booth."

Dimensions

A Peninsula Booth is usually 20 feet by 20 feet (6.10m by 6.10m) or larger. When a Peninsula Booth backs up to two Linear Booths, the back wall is restricted to 4 feet (1.22m) high within 5 feet (1.52m) of each aisle, permitting adequate line of sight for the adjoining Linear Booths. Maximum height range allowance is 20 feet (6.10m), including signage for the center portion of the back wall. Double-sided signs, logos and graphics shall be set back 10 feet (3.05m) from adjacent booths.

Included:

8 feet (2.4m) high x 10 feet (3.05m) wide back wall drape (in back center) and 3 feet (.9) high back wall drape (5 feet/1.5m on each side from aisle) Company identification sign

Exhibitors are required to adhere to Union Guidelines.

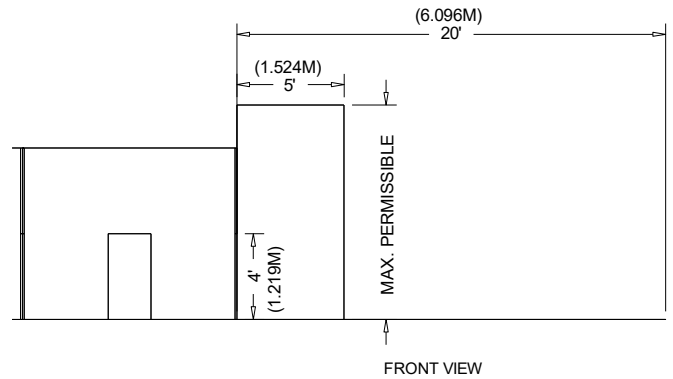
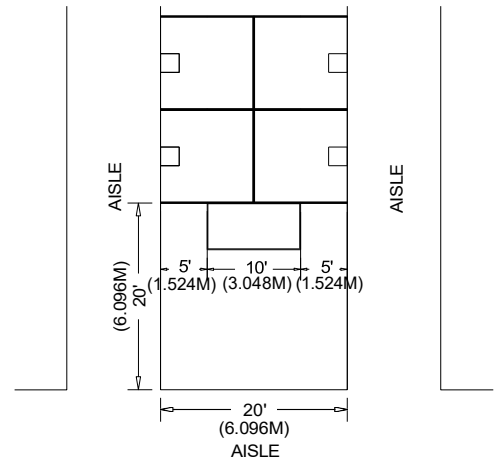
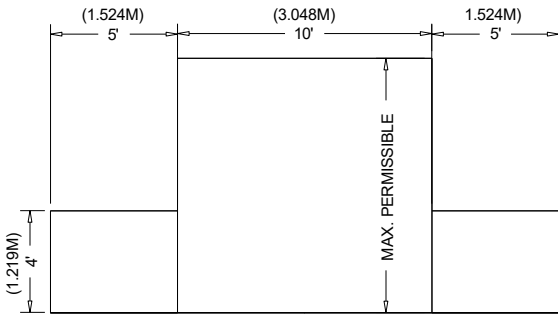

Hanging Signs

- Overhead signs are allowed (See hanging signs regulations).
- SPIE recommends that exhibitors contact the Service Contractor to request a cost estimate for hanging signs.
- Must be shipped to Advanced Warehouse

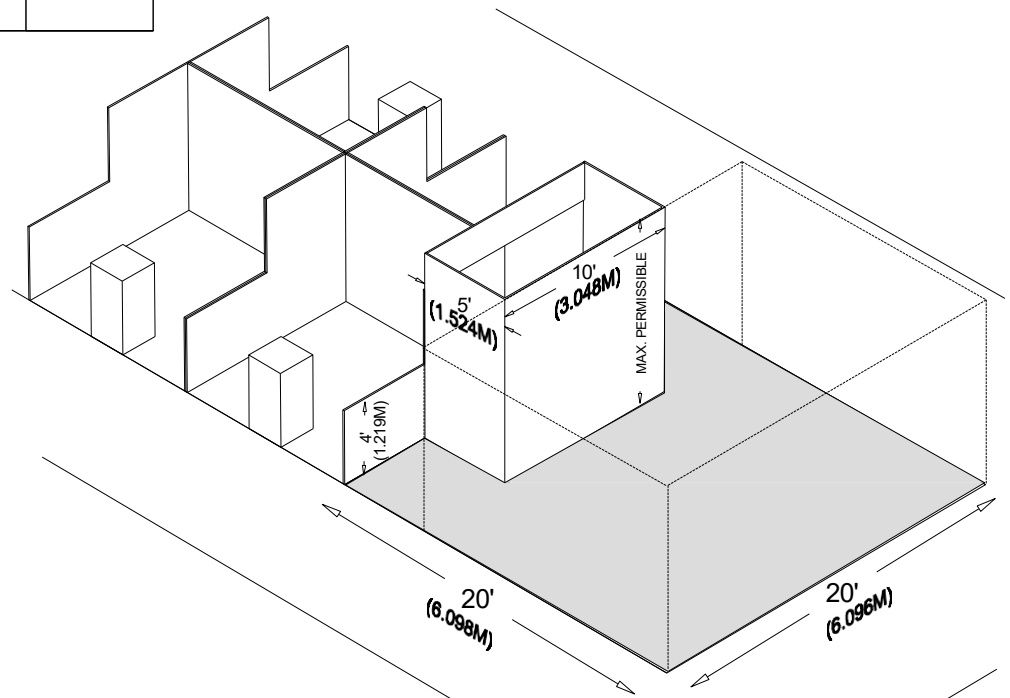

PENINSULA BOOTH

Split Island Booth

A Split Island Booth is a Peninsula Booth which shares a common back wall with another Peninsula Booth.

Dimensions and Use of Space

The entire Cubic Content of this booth may be used, up to the maximum allowable height, without any back wall Line-of-Sight restrictions. Maximum height allowance is 20 feet (6.10m), including signage. Double-sided signs, logos and graphics shall be set back 10 feet (3.05m) from adjacent booths.

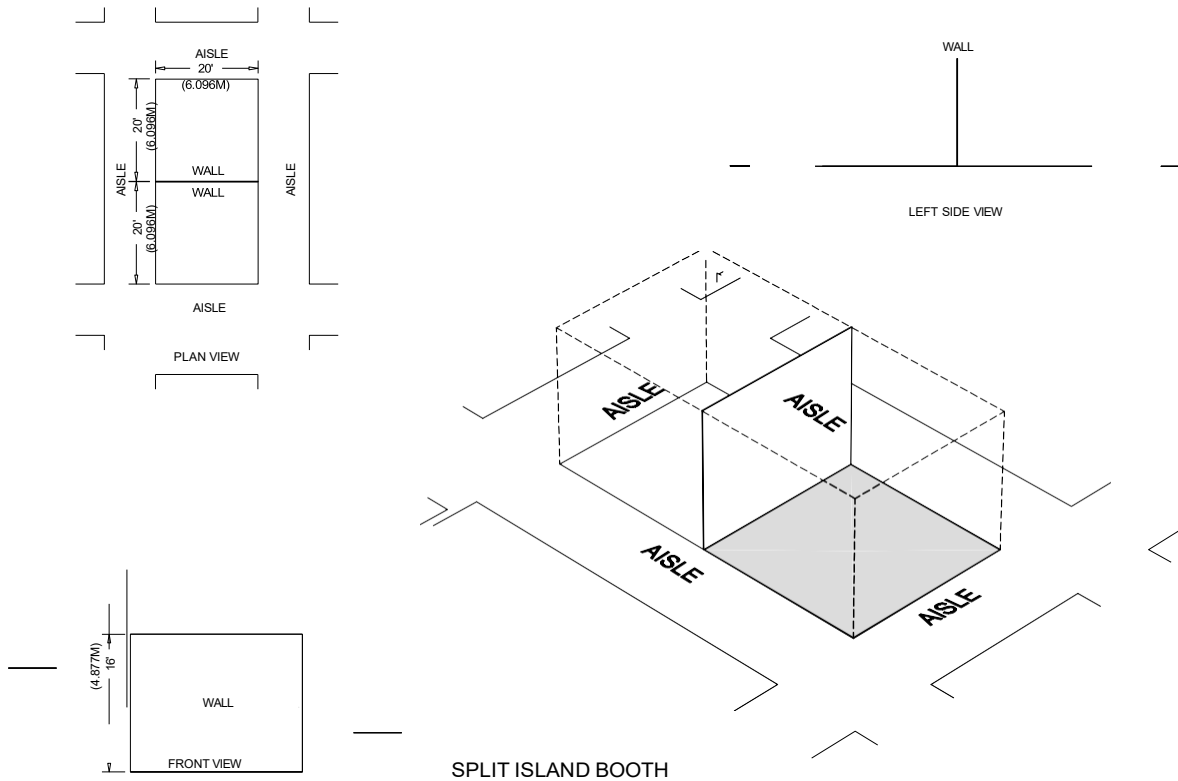

Island Booth

An Island Booth is any size booth exposed to aisles on all four sides.

Dimensions

An Island Booth a minimum 20 feet by 20 feet (6.10m by 6.10m) or larger, although it may be configured differently.

Use of Space

The entire cubic content of the space may be used up to the maximum allowable height, 20 feet (6.10m), including signage.

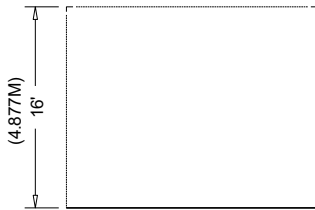
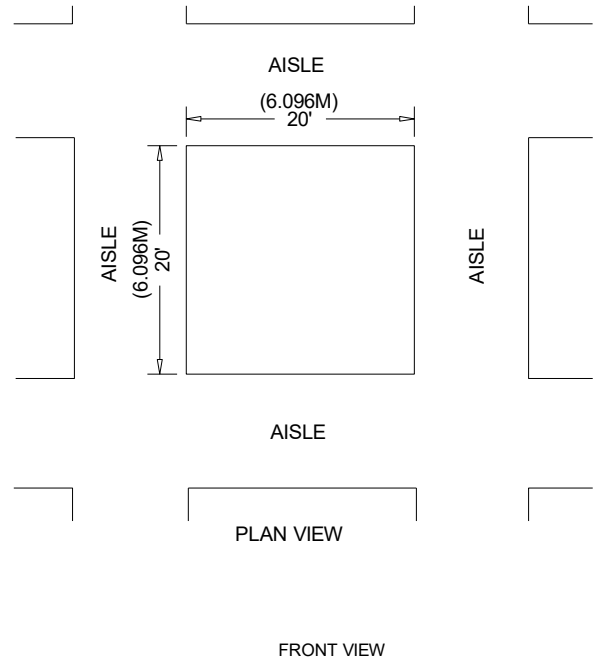

Exhibitors are required to adhere to Union Guidelines. Overhead signs are allowed ([See hanging signs regulations](#)).

SPIE recommends that exhibitors contact the Service Contractor to request a cost estimate for hanging signs.

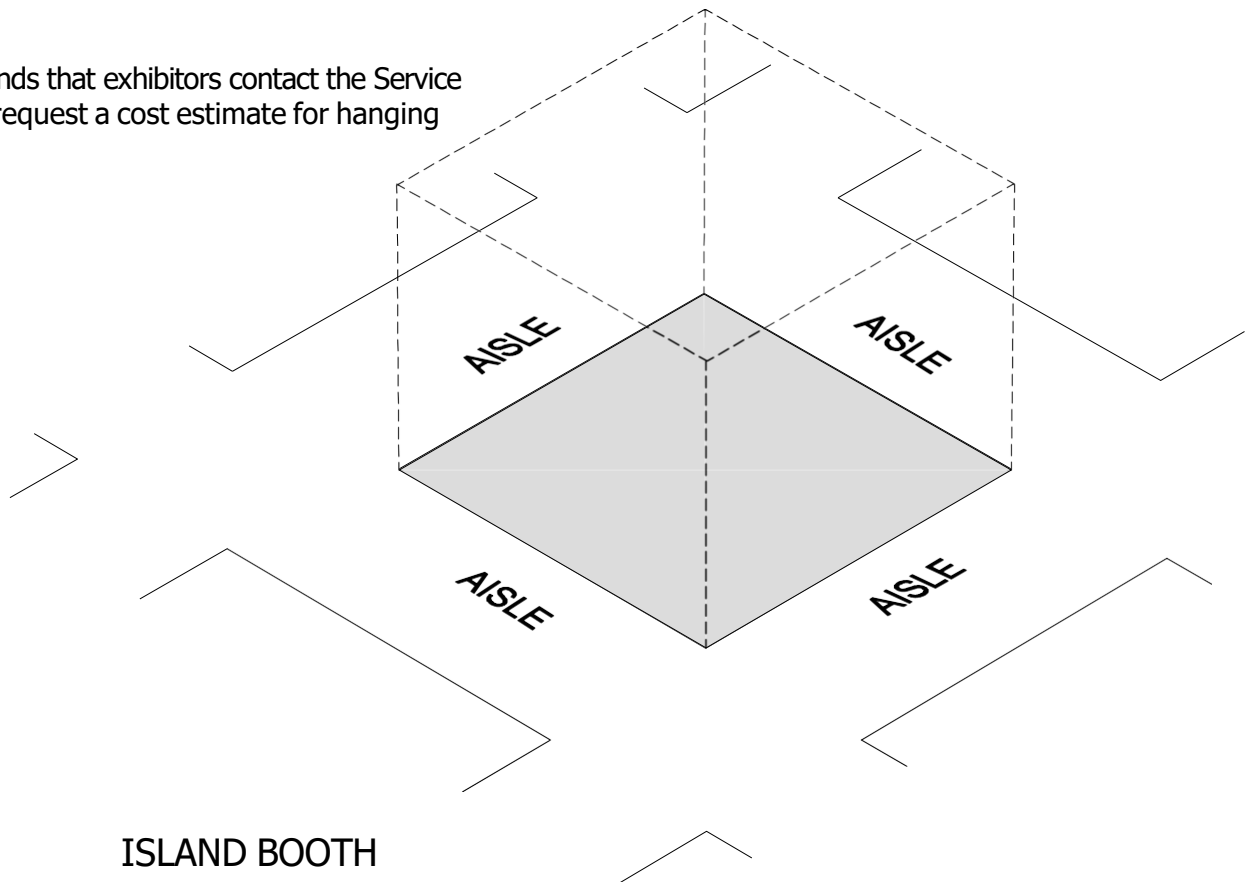

**Extended Header Booth
20ft(6.10m) or Longer**

An Extended Header Booth is a Linear Booth 20 feet (6.10m) or longer with a center extended header.

Dimensions and Use of Space

All guidelines for Linear Booths apply to Extended Header Booths, except that the center extended header has a maximum height of 8 feet (2.44m), a maximum width of 20 percent of the length of the booth, and a maximum depth of 9 feet (2.7m) from the back wall.

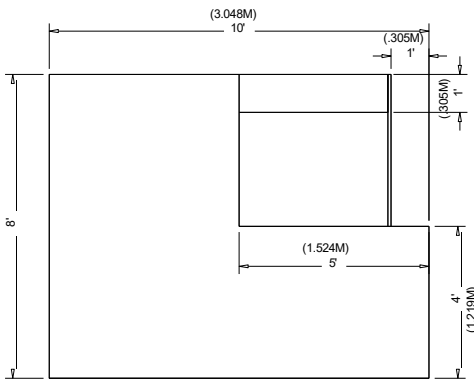

LEFT SIDE VIEW

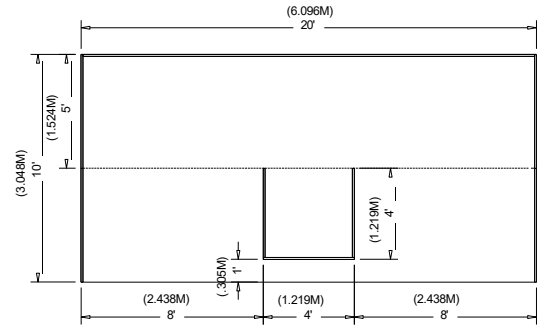

PLAN VIEW

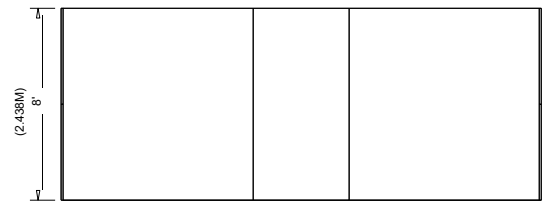

FRONT VIEW

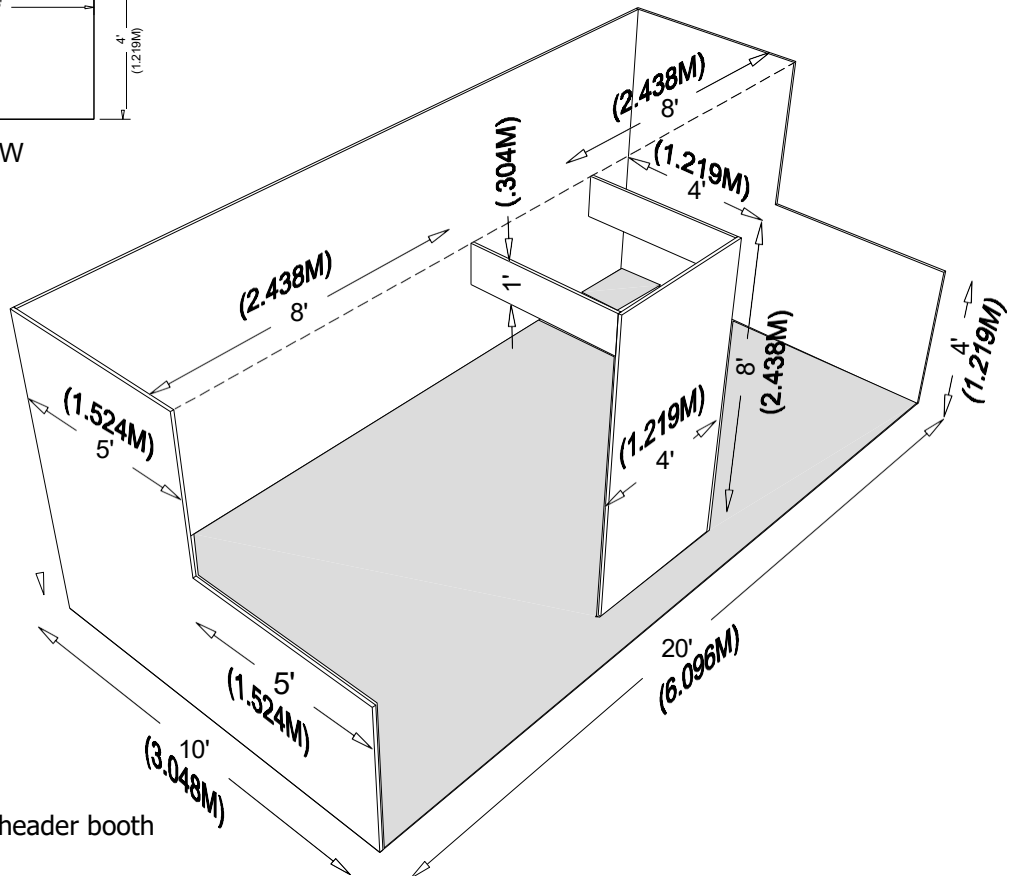

10 foot x 20 foot extended header booth

Other Important Considerations

Canopies and Ceilings

Canopies, including ceilings, umbrellas and canopy frames, can be either decorative or functional (such as to shade computer monitors from ambient light or to allow for hanging products). Canopies for Linear Booths should comply with Line-of-Sight requirements. (See "Use of Space" for Linear Booths). The bottom of the canopy should not be lower than 7 feet (2.13m) from the floor within 5 feet (1.52m) of any aisle. Canopy supports should be no wider than 3 inches (.08m). This applies to any booth configuration that has a sight line restriction, such as a Linear Booth. Fire and safety regulations in many facilities strictly govern the use of canopies, ceilings and other similar coverings. Check with the appropriate local agencies prior to determining specific exhibition rules.

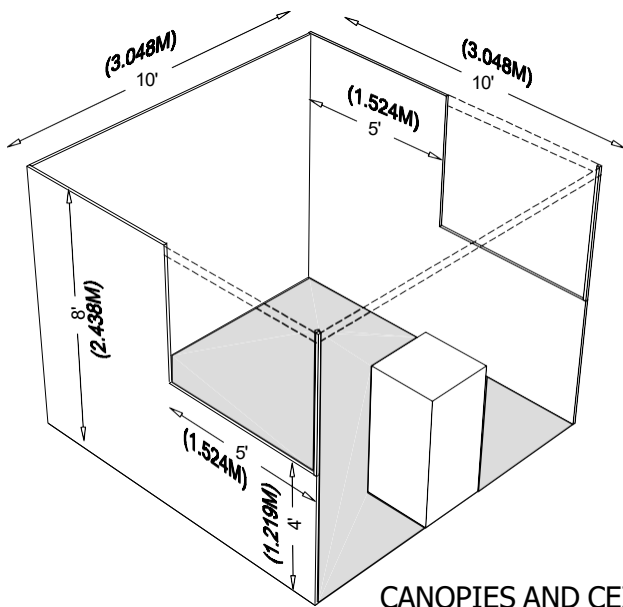

CANOPIES AND CEILINGS

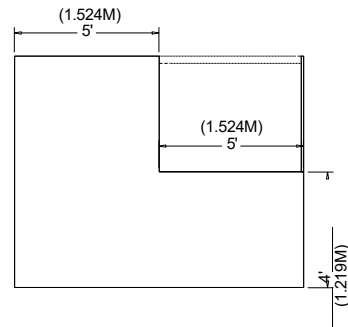
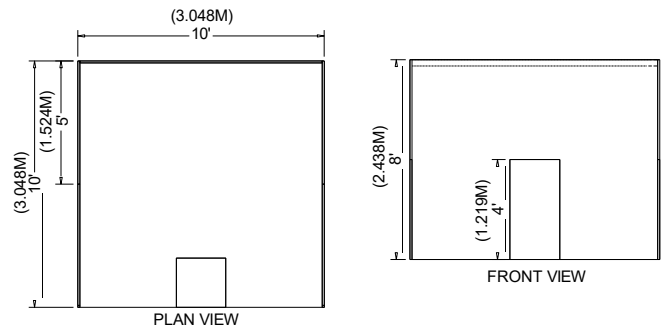

LEFT SIDE VIEW

Hanging Signs & Graphics

Hanging Signs and Graphics are allowed in all standard Peninsula and Island Booths, to a maximum height range of 20 feet (6.10m) from the top of the sign. The distance is measured from the floor to the top of the sign. Whether suspended from above, or supported from below, they should comply with all ordinary use-of-space requirements. For example, the highest point of any sign should not exceed the maximum allowable height for the booth type.

Hanging Signs and Graphics should be set back 10 feet (3.05m) from adjacent booths and be directly over contracted space only.

Approval for the use of Hanging Signs and Graphics, at any height, should be received from the exhibitions organizer at least 60 days prior to installation. Variances may be issued at the exhibition management's discretion. Drawings should be available for inspection. SPIE recommends that exhibitors contact the Service Contractor to request a cost estimate for hanging signs.

Towers

A Tower is a free-standing exhibit component separate from the main exhibit fixture. The height restriction is the same as that which applies to the appropriate exhibit space configuration being used. Towers in excess of 8 feet (2.44m) should have drawings available for inspection. Fire and safety regulations in many facilities strictly govern the use of towers. A building permit or safety lines may be required.

Other Important Considerations

Multi-story Exhibit

A Multi-story Exhibit is a booth where the display fixture includes two or more levels. In many cities, a Multi-story Exhibit requires prior approval by the exhibit facility, and/or relevant local government agency, as well as show management because it is deemed to be a "structure" for building purposes. The city building department generally needs to issue a building permit based on an application and drawings prepared and submitted by a licensed architect or engineer. Exhibitors should obtain local building regulations early on to ensure that all time constraints are met. Exhibitions and events organizers should be prepared to assist exhibitors in this application process.

Issues Common To All Booth Types

Americans with Disabilities Act (ADA) - *Please share this information with your booth builder*

All exhibiting companies are required to be in compliance with the Americans with Disabilities Act (ADA), and are encouraged to be sensitive, and as reasonably accommodating as possible, to attendees with disabilities. Information regarding ADA compliance is available from the U.S. Department of Justice ADA Information Line (800) 514-0301, and from the ADA website at www.ada.gov. Some examples of how to design an exhibit for ADA compliance:

- Make exhibits wheelchair accessible by ramping raised exhibit flooring without extending a ramp into the aisle. **Note:** a standard wheelchair ramp should have a grade no steeper than 1:12. This means that for every inch of rise (change in height), there should be 12 inches of run (change in length)
 - Ramp the entry or use hydraulic lifts to trailer exhibits
 - Avoid double-padded plush carpet to ease mobility device navigation
 - Provide the same attendee experience on both levels of a two-story exhibit
 - Offer a signer or other auxiliary hearing-impaired apparatus for sound presentations or have a printed copy of the presentation available
 - Run an audio presentation for people with sight problems
 - Arrange touch screen displays at a height to accommodate a person sitting in a wheelchair
- To avoid heavy fines by the U. S. Department of Justice, exhibitors must adhere to the ADA rules. Exhibits are not exempt from ADA compliance.*

Structural Integrity

All exhibit displays should be designed and erected in a manner that will withstand normal contact or vibration caused by neighboring exhibitors, hall laborers, or installation/dismantling equipment, such as fork lifts. Displays should also be able to withstand moderate wind effects that may occur in the exhibition hall when freight doors are open. Refer to local building codes that regulate temporary structures.

It is recommended that all exhibits 20 feet by 20 feet (6.10m by 6.10m) and larger require a drawing, plans or renderings, preferably digital, to be submitted to the show organizer, and to the show's general service contractor. Exhibitors should ensure that any display fixtures such as tables, racks, or shelves are designed and installed properly to support the product or marketing materials to be displayed.

Flammable and Toxic Materials

All materials used in display construction or decorating should be made of fire retardant materials and be certified as flame retardant. Samples should also be available for testing. Materials that cannot be treated to meet the requirements should not be used. A flame-proofing certificate should be available for inspection. Exhibitors should be aware of local regulations regarding fire/safety and environment which must be adhered to.

Exhibitors should dispose of any waste products they generate during the exhibition in accordance with guidelines established by the Environmental Protection Agency and the facility.

Issues Common to All Booth Types *(continued)*

Electrical

Every exhibit facility has different electrical requirements. However, minimum guidelines are suggested:

- All 110-volt wiring should be grounded three-wire.
- Wiring that touches the floor should be "SO" cord (minimum 14-gauge/three-wire) flat cord, which is insulated to qualify for "extra hard usage."
- Cord wiring above floor level can be "SJ" which is rated for "hard usage."
- Using zip cords, two-wire cords, latex cords, plastic cords, lamp cords, open clip sockets, and two-wire clamp-on fixtures is not recommended and is often prohibited. Cube taps should be prohibited.
- Power strips (multi-plug connectors) should be UL approved, with built-in overload surge protectors.
- Local code commonly requires access to electrical cords and connections along the back wall of exhibit booths; typically, the back 9 inches of the space should remain accessible for this purpose. (This would apply to all booth types with a back wall.)

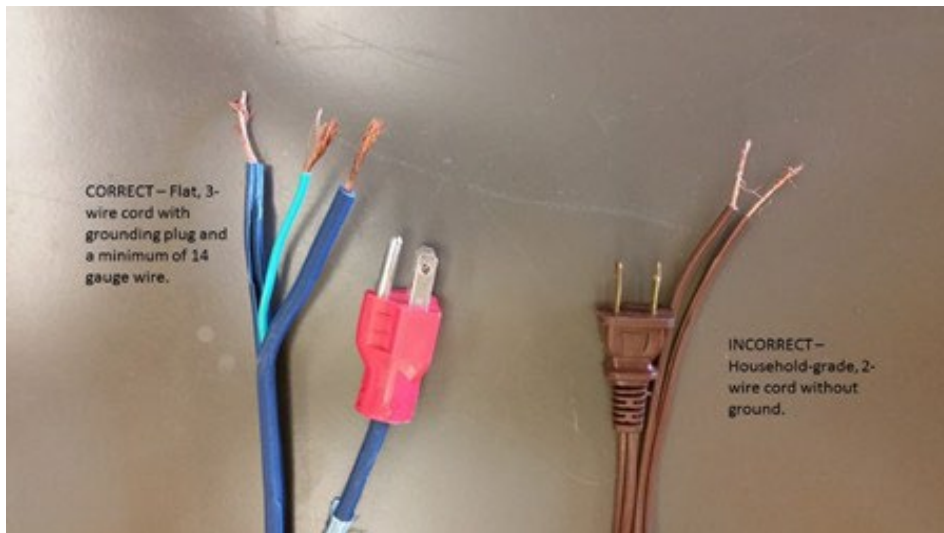

Lighting

Exhibitors should adhere to the following suggested minimum guidelines when determining booth lighting:

- No lighting, fixtures, lighting trusses, or overhead lighting are allowed outside the boundaries of the exhibit space. Exhibitors intending to use hanging light systems should submit drawings to exhibition management for approval.
- Lighting, including gobos, should be directed to the inner confines of the booth space. Lighting should not project onto other exhibits or exhibition aisles. Additional materials may be required to defuse back lit displays.
- Lighting that is potentially harmful, such as lasers, ultraviolet lights or flashing or strobe lights that can trigger photosensitive epilepsy should comply with facility rules and be approved in writing by exhibition management.
- Lighting that spins, rotates, pulsates, and other specialized lighting effects should be in good taste and not interfere with neighboring exhibitors or otherwise detract from the general atmosphere of the event.
- LED lights can be very bright yet generally generate less heat.
- Currently, some convention facilities are not allowing certain types of quartz halogen lighting fixtures in exhibits due to potential fire hazards. Check with exhibition management.
- Reduced lighting for theater areas should be approved by the exhibition organizer, the utility provider, and the exhibit facility.
- Island or Peninsula spaces that contract for external lighting are restricted to Leko lighting only (no quartz). Light bars must be hung in the neutral aisle space only and cannot be hung over other exhibits.

Common to All Booth Types (continued)

Demonstrations

As a matter of safety and courtesy to others, exhibitors should conduct sales presentations and product demonstrations in a manner which assures all exhibitor personnel and attendees are within the contracted exhibit space and not encroaching on the aisle or neighboring exhibits. It is the responsibility of each exhibitor to arrange displays, product presentation, audio visual presentations, and demonstration areas to ensure compliance. Exhibitors should be aware of local regulations regarding fire/safety and environment which must be adhered to.

Special caution should be taken when demonstrating machinery or equipment that has moving parts, cooking equipment with an open flame, or any product that is otherwise potentially dangerous. Exhibitors should establish a minimum setback of 3ft (.91m) and/or install hazard barriers as necessary to prevent accidental injury to spectators. Additionally, demonstrations should only be conducted by qualified personnel.

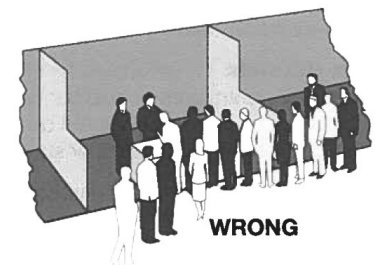
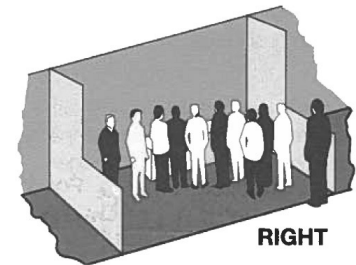

Sound/Music

In general, the use of sound equipment in booths is permitted as long as the noise level does not disrupt the activities of neighboring exhibitors. Speakers and other sound devices should be positioned to direct sound inward (to be contained within the booth) rather than outward (toward aisles and other exhibitor booths). Generally, sound and noise should not exceed 85 decibels when measured from the aisle immediately in front of a booth. If an exhibitor or attendee is standing within ten feet of an exhibitor's booth and cannot carry on a normal voice-level conversation, the noise source is too loud. (Refer to the U.S. Occupational Safety and Health Act [OSHA] at www.osha.gov for more information.)

Exhibitors should be aware that music played in their booths, whether live or recorded, may be subject to laws governing the use of copyrighted compositions. Authorized licensing organizations, including but not limited to ASCAP, BMI and SESAC, collect copyright fees on behalf of composers and publishers of music. It is the exhibitors' responsibility to be informed of copyright laws and submit fees to the appropriate organizations.

Storage

Fire regulations in most exhibit facilities prohibit storing product, literature, empty packing containers, or packing materials behind back drapes or under draped tables. In most cases, however, exhibitors may store a limited supply of literature or product appropriately within the booth area, so long as these items do not impede access to utility services, create a safety problem, or look unsightly.

Vehicles

Rules vary depending on the facility, but generally it is required that vehicles on display have no more than one fourth tank of gas. The filler cap should be sealed and the batteries disconnected. External chargers are usually recommended for demonstration purposes.