

Exhibition Guide

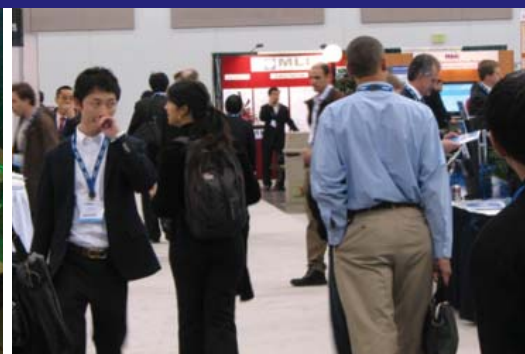

SPIE Europe Photonics Europe

Exhibition: 8–10 April 2008 • Conference: 7–10 April 2008
Palais de la Musique et des Congres, Strasbourg, France

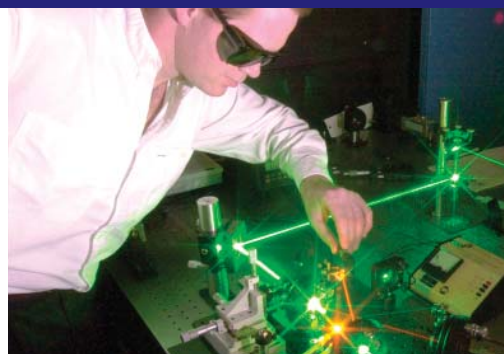



FullWAVE 6.0

BeamPROP 8.0

ModePRO

Solve 4.0

ModeSYS 4.6

FemSIM 3.0

GratingMOD 3.0

MO

DiffractMOD 3.0

MOST 2.0

BandSolve 4.0

Artifex 4.4

LASERMOD 2.2

MetroWAND 3.5

BeamPROP

ModeSYS 4.6

BandSolve 4.0

LASERMOD 2.2

FemSIM 3.0

OPTSIM 4.7

FullWAVE 6.0

Artifex 4.4

ModeS

ModePROP 1.0

GratingMOD 3.0

DiffractMOD 3.0

4.0

BeamPROP 8.0

OPTSIM 4.7

MetroWAND 3.5

**SOFTWARE TOOLS FOR
FULL SPECTRUM PHOTONIC & NETWORK DESIGN AUTOMATION**

RSOFT

Design Group

Tool Focus

Photonic
Component
Design Suite

Optical
Communication
Design Suite

www.rsoftdesign.com

Events

SPIE EUROPE PHOTONICS EUROPE,
PALAIS DE LA MUSIQUE ET DES CONGRÈS,
STRASBOURG, FRANCE,
8-10 APRIL

**Visit us at
Booth 320**

Sponsored by



Cooperating Organisations



Sponsors



Media Partner



Promotional Partners

- AT-Fachverlag
- Carl Hanser Verlag
- EDP Sciences
- EuroPhotonics
- Image Analysis & Stereology
- Laser Focus World
- Materials Today
- Optics & Laser Europe
- OptoIndex
- Photonics Spectra
- Photoniques
- Royal Society of Chemistry
- Spectroscopy Magazine
- Taylor & Francis - Contemporary Physics
- Taylor & Francis - Fiber and Integrated Optics
- Taylor & Francis - International Journal of Optomechatronics
- Taylor & Francis - Modern Optics
- Wiley VCH GmbH & Co. KGaA
- Yole Developpement



Event partners

- Photonex
- Vision



SPIE Europe Photonics Europe

Exhibition: 8–10 April 2008

Conference: 7–10 April 2008

Palais de la Musique et des Congrès, Strasbourg, France

Contents

- Exhibitor Listing** 2
- Exhibition Floor Plan** 3
- Palais de la Musique et des Congrès Floor Plan** 4
- Industry Prospective Programme** 6-7
- Photonics Innovation Village** 8-9
- Special Events** 10
- Product Tutorials** 12
- Course/Workshops** 14
- General Information** 15
- Exhibitor Directory** 16-39
- SPIE Corporate Members** 40-41
- Product Category List** 42-43



**SPIE Europe thanks the following sponsors
for their generous support**

Attendee Pens



Stand #511
www.micos.ws

Coffee Breaks



Stand #420
www.klastech.de

Conference Bags



Stand #208
www.nature.com

Exhibitor Lounge



Stand #430
www.europescience.com

Lanyards



Stand #204
www.photond.com

Pastries



Stand #511
www.micos.ws

Vertical Banner



Stand #231
www.hamamatsu.fr

Exhibitor List

Exhibitor list as of 3 March 2008.

AMA Association for Sensor Technology	#209
A.T. Wall Company	#224
AFOP - French Optics and Photonics Manufacturers Association	#124
AHF analysentechnik AG	#316
Alcatel Thales III V Lab	#329
AT-Fachverlag GmbH	#534
Avantes	#232
Becker & Hickl GmbH	#405
Bookham	#317
Breault Research Organization	#117
Brush Ceramic Products	#104
Carl Hanser Verlag	#530
Cedrat Technologies	#118
CEIT	#323
CILAS	#416
Conerefringent Optics SL	#508
Crystal Fibre	#306
CST - Computer Simulation Technology	#226
CVI Melles Griot Ltd.	#507
Draka	#230
EDP Sciences	#532
EKSPLA Co.	#330
Electro Optics Magazine	#430
Consortium	#331
ePIXnet	#431
Epner Technology, Inc.	#423
EQ Photonics GmbH	#223
ET Enterprises Ltd	#328
European Optical Society	#536
EuroPhotonics	#100
Fibercore Ltd	#515
Fibercryst	#426
FiberTech Optica Inc.	#415
Fischer Connectors	#122
Flexible Optical BV	#514
FRAMOS GmbH	#106
Frank Optic Products GmbH	#105
Fraunhofer Heinrich Hertz Institut	#321
Fujian CASTECH Crystals, Inc.	#501
Gorman-Rupp Industries	#413
GWU-Lasertechnik GmbH	#501
Hamamatsu	#231
HC Photonics Corp	#501
Heptagon	#521
HOLOEYE Photonics AG	#309
HORIBA Jobin Yvon SAS	#327
id Quantique SA	#405
Impex HighTech GmbH	#411
Innolume GmbH	#115
Institut d'Optique Graduate School	#437
International Society for Stereology	#529
iXFiber	#126
KERDRY	#120
Kimoga Material Technology Co., Ltd.	#520
KLASTECH	#420
Laser Components GmbH	#220
Laser Focus World	#414
Laser Zentrum Hannover e.V. (LZH)	#505
LEONI Fiber Optics GmbH	#406
Leukos	#123
LINOS Photonics France	#307
Lovalite	#121
Lumera Laser GmbH	#310
Lumerical Solutions, Inc.	#121
M.C.S.E.	#128
Mad City Labs, Inc.	#214
Materials Today	#435
Menlo Systems GmbH	#517

Exhibition Floor Plan

- Messe Stuttgart #524
- MICOS GmbH #511
- Nature Publishing Group #208
- NEMO (Network of Excellence on
Micro-Optics) #217
- New Focus, Inc. #317
- Newport Spectra-Physics #205
- NEYCO #212
- NIL Technology #125
- NP Photonics #501
- Nufern #428
- NuSil Technology #525
- Ocean Optics #110
- OLLA Project #429
- Omega Optical, Inc. #107
- OpTIC #333
- Optics & Laser Europe #312
- Optics Pages #527
- OptiGrate #510
- Optima Research #131
- OptoIndex #531
- Opton Laser International #130
- Optronis GmbH #216
- OXXIUS #304
- Phoenix BV #315
- Photon Design #204
- Photonex 2008 #527
- Photonic Cleaning Technologies #421
- Photonics 4 Life - Network of Excellence #427
- Photonics Spectra - Laurin Publishing #100
- Photonik Zentrum Hessen in Wetzlar AG #222
- Physik Instrumente (PI) GmbH & Co. #308
- Point Source #113
- Quantel #305
- Raicol Crystals Ltd. #206
- Rhenaphotonics Alsace #533, 535, 537, 539
- Royal Society of Chemistry #541
- RSoft Design Group #320
- RSP Technology BV #424
- Santec Europe Ltd. #409
- Scientec #412
- SEDI Fibres Optiques #313
- SEMELAB PLC #109
- Sill Optics GmbH & Co., KG #221
- SIOF-Italian Society of Optics and Photonics #516
- Space Light srl #518
- Spectroscopy Magazine #433
- SphereOptics GmbH #504
- Spiricon GmbH #419
- Springer #211
- Stanford Computer Optics GmbH #114b
- Taylor & Francis - Contemporary Physics #528
- Taylor & Francis - Fiber and Integrated Optics #528
- Taylor & Francis - Informa UK Ltd. #528
- Taylor & Francis - International Journal of
Optomechatronics #528
- Taylor & Francis - Journal of Modern Optics #528
- THALES Laser #506
- The Institution of Engineering and
Technology (IET) #425
- Thorlabs GmbH #517
- TSP Diffusion #417
- UCM AG #116
- Unice E-O Services Inc. #422
- Universal Photonics, Inc. #207
- VTT Technical Research Centre of Finland #129
- Wiley-VCH GmbH & Co. KGaA #523
- Xiton Photonics GmbH #501
- XLITH GmbH #432
- Yole Développement #225
- ZODIAC #322

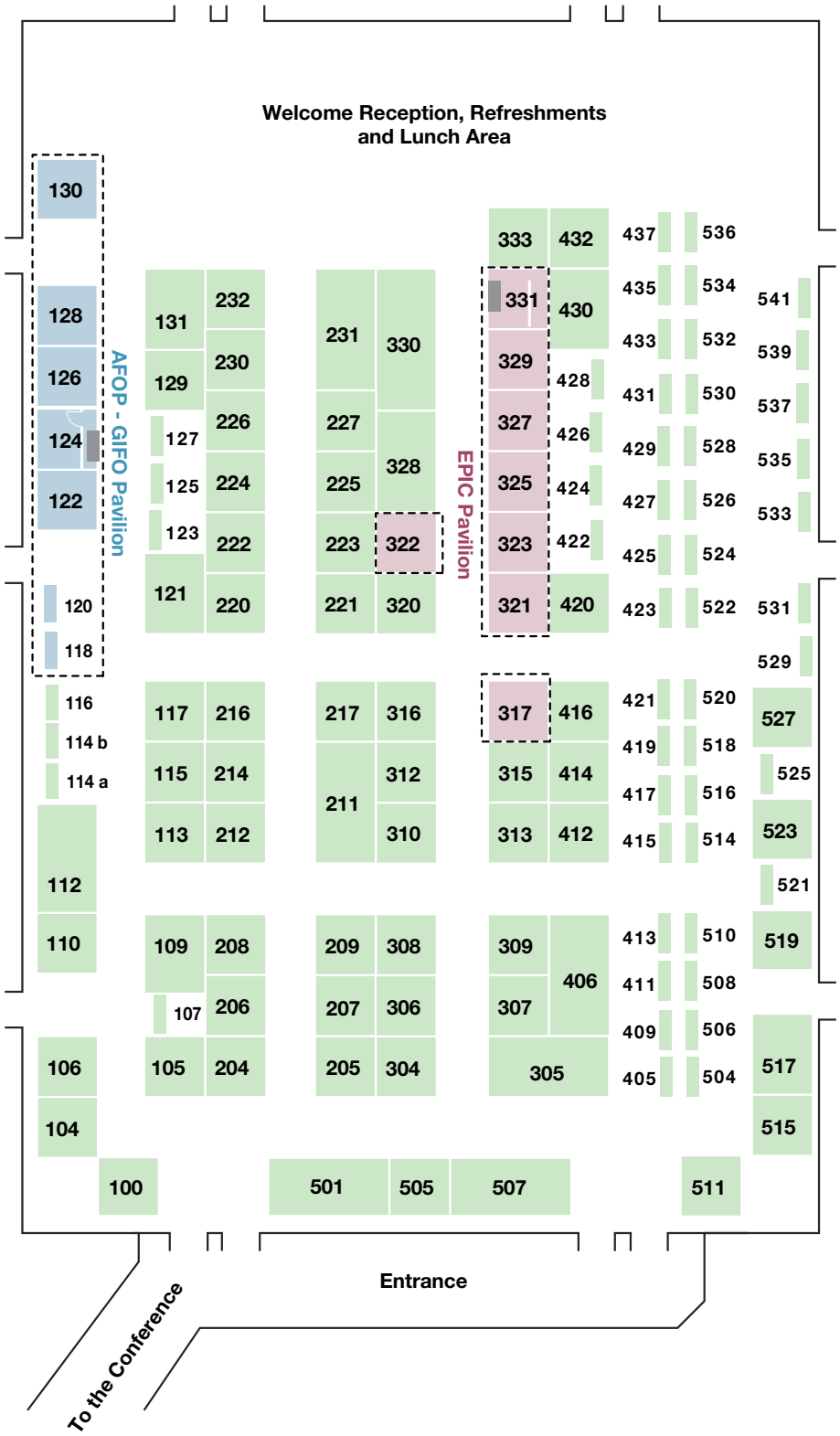

Advertiser Index

- Alcatel Thales III-V Lab p. 11
- CVI Melles Griot Ltd. Cover 4
- ET Enterprises Ltd. p. 23
- EPIC—European Photonics Industry Consortium p. 13
- KLASTECH—Karpushko Laser Technologies p. 19
- LINOS Photonics France p. 17
- Photoniques p. 5
- RSoft Design Group Cover 2
- Space Light srl p. 21

Palais de la Musique et des Congrès Floor Plan

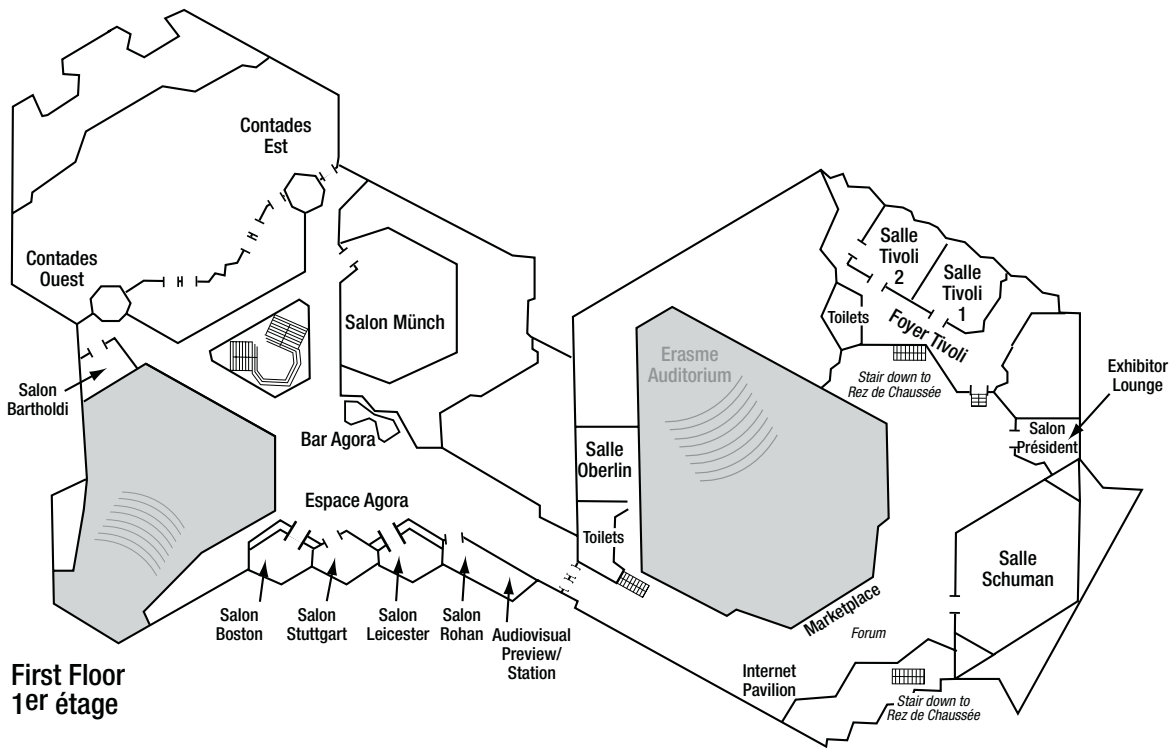

**First Floor
1er étage**

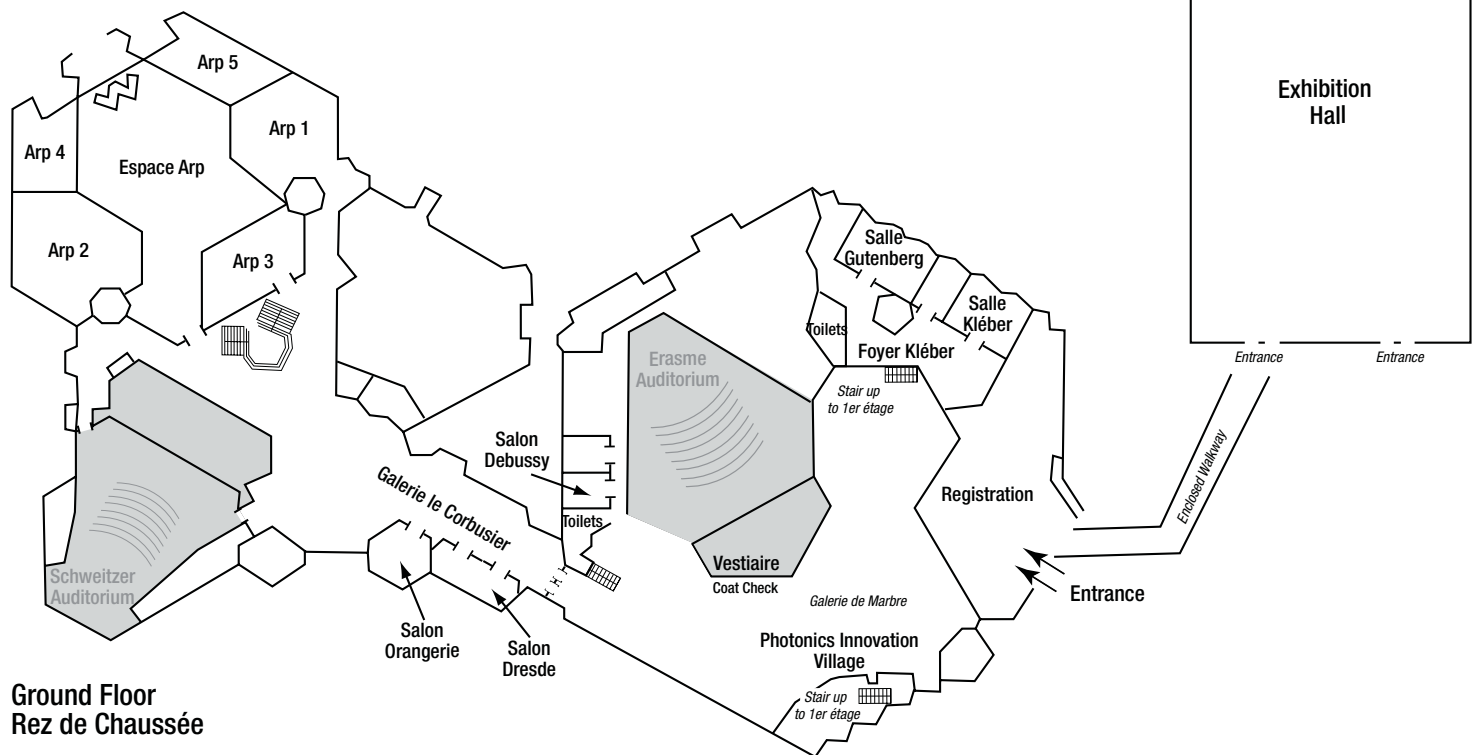

**Ground Floor
Rez de Chaussée**

Photoniques

The French magazine specializing in Optics-Photonics

1 Photoniques : the magazine of the French Optical Community

Photoniques, magazine of the French Optical Society, establishes links and partnerships between all the entities working in Optics-Photonics : at national level with AFOP (French Manufacturers Association in Optics and Photonics) and in each region of France.

2 Photoniques :

The source of information for all the professionals in the field of Optics-Photonics in France. In each issue : industry news, technical articles written by specialists, new products...

3 A useful and efficient circulation : 7 500 copies

After 7 years of existence, cooperation and networking with the specialists of the optic world in France, Photoniques has built a large qualified database of potential users : researchers, technicians, engineers and managers, from industry such as communications, industrial vision, lasers, test and measurements, imaging/displays...

Are you interested in the French optics and photonics markets? Photoniques is your partner!

**How to keep you informed about Optics-Photonics in France?
Become a Photoniques reader!**

For additional information,
contact: Olga Sortais : + 33 1 34 04 21 44
o.sortais@photoniques.com
to request an issue of Photoniques and a media kit



Industry Perspectives Programme

Included with Conference registration.

Individual Sessions can be purchased at the Cashier. Individual sessions, €100.

As a new addition to Photonics Europe, the Industry Perspectives Programme will provide a series of executive briefings covering key technologies and sectors.

Come hear key members of Europe's photonics industry discuss their successes, future plans and the way in which they intend to maximize their market penetration and growth. Hear reviews of the European Innovation landscape highlighting geographical areas of strengths in areas such as business R&D, knowledge transfer and demonstrate the outcomes from recent successful European-funded industry programmes.

The sessions will deliver a strategic perspective into each application area, allowing you to uncover and confirm the future prospects for your business. Benchmark your aspirations for your business and technology against some of Europe's leading companies and engage with them as a potential supplier or partner. You will hear presentations from Philips, Audi, PCO, Coherent Scotland, GlaxoSmithKline, Carl Zeiss, Yole Développement, Koheras and Fraunhofer on their successes and strategic priorities.

Tuesday 8 April

Morning Session

Photovoltaics



10.15 to 10.45 hrs.

Photovoltaics - Market and Technology Trends

Gaëtan Rull, Market Analyst for New Energy Technologies, Yole Développement

10.45 to 11.15 hrs.

High Throughput Manufacturing for Bulk Heterojunction PVs

Markus Scharber, Head of Materials Group, Konarka

11.15 to 11.45 hrs.

Managing JGrowth in the Production of Thin Films

(To be confirmed.)

Dr. Immo Kotschau, Director of Research and Development, Centrotherm GmbH

11.45 to 12.30 hrs.

End to End Mass Production of Silicon Thin Film Modules

Detlev Koch, Head of BU Solar Thin Films & Senior Vice President, O C Oerlikon Balzers AG

Break – 12.30 to 14.00 hrs.

Afternoon Session

MEMS/MOEMS



14.00 to 14.30 hrs.

Market Trends and Technical Advances in M(O)EMS

Dr. Eric Mounier, Manager for MEMS & Optoelectronics and Micronews Chief Editor, Yole Développement

14.30 to 15.00 hrs.

Inorganic/Organic Hybrid Polymers (ORMOCER) for Optical Interconnects

Dr. Michael Popall, Head of Microsystems and Portable Power Supply, Fraunhofer ISC

15.00 to 15.30 hrs.

Future MOEMS and Photonic Microsystems

Dr. Thomas Hessler, Director Axetris, Leister Process Technologies

15.30 to 16.15 hrs.

Innovations in MOEMS product development

Prof. Hubert Karl, Director, Fraunhofer IPMS

Wednesday 9 April

Morning Session

Multimedia, Displays and Lighting

10.15 to 10.45 hrs.

Plasmonics for Photonics: Challenges and Opportunities

Ross Stanley, Section Head: MOEMS & Nanophotonics, CSEM

10.45 to 11.15 hrs.

Photonic Microsystems for Displays

Edward Buckley, VP Business Development, Light Blue Optics Ltd.

11.15 to 11.45 hrs.

Matrix-Beam – the antiglare LED-high beam

Benjamin Hummel, Research for Concept Lighting Technologies, Audi

11.45 to 12.30 hrs.

High Brightness OLEDs for Next Generation Lighting

Peter Visser, Project Manager, OLLA Project, The Netherlands

Break – 12.30 to 14.00 hrs.



Wednesday 9 April

Afternoon Session

OPERA 2015: European Photonics - Corporate and Research Landscape

13.30 to 13.45 hrs.

Optics and Photonics in the 7th Framework Programme

Gustav Kalbe, Head of Sector - Photonics, Information Society and Media, Directorate General, European Commission

13.45 to 14.00 hrs.

OPERA 2015: Aims, Results and link to Photonics²¹

Markus Wilkens, VDI

14.00 to 14.20 hrs.

European Photonics Industry Landscape

Bart Snijders, TNO

14.20 to 14.40 hrs.

European Photonics Research Landscape

Marie-Joëlle Antoine, Optics Valley

14.40 to 15.00 hrs.

Resources for Photonics Development

Peter Van Daele, IMEC

Break – 15.00 to 15.15 hrs.

15.15 to 15.35 hrs.

Towards the Future on Optics and Photonics Research

Dr. Eugene Arthurs, SPIE Europe (UK)

15.35 to 16.15 hrs.

Strategic Opportunities for R&D in Europe

Mike Wale, Bookham, UK

16.15 to 16.45 hrs.

A Sustainable Business Model for Optics and Photonics

David Pointer, Managing Director, Point Source (Pending)

16.45 to 17.15 hrs.

Final Open Discussion

Chaired by: **Gustav Kalbe**, Head of Sector - Photonics, Information Society and Media, Directorate General, European Commission

Thursday 10 April

Morning Session

Imaging

10.15 to 10.45 hrs.

High Resolution Imaging detectors for invisible light-Development and Industrialisation

Hans Hentzell, CEO, Acreo

10.45 to 11.15 hrs.

(Presentation to be confirmed.)

11.15 to 11.45 hrs.

Raman Spectroscopy, Raman Imaging and Future Trends

Sophie Morel, Sales Manager, Molecular & Microanalysis Division, HORIBA Jobin Yvon

11.45 to 12.30 hrs.

World Markets for Lasers and Their Application

Steve Anderson, Associate Publisher/Editor-in-Chief, *Laser Focus World*

Break – 12.30 to 14.00 hrs.

Afternoon Session

Biomedical and Healthcare Photonics

14.00 to 14.30 hrs.

Photonic Systems for Biotechnology Research

Karin Schuetze, Director of R&D, Carl Zeiss Microimaging

14.30 to 15.00 hrs.

Photonics 4 Life

Prof. Jeürgen Popp, Director, IPHT Germany

15.00 to 15.30 hrs.

Laser System Development for Biophotonics

Chris Dorman, Managing Director, Coherent Scotland

15.30 to 16.15 hrs.

Supercontinuum Light - a paradigm shift in laser sources for biophotonics

Jakob Dahlgren Skov, CEO, Koheras

Husain Imam, Business Development Manager, Koheras

Photonics Innovation Village

Tuesday to Thursday during Exhibition Hours

Location: Galleri de Marbre

The Photonics Innovation Village will showcase the latest projects and breakthroughs from optics-photonics researchers at universities, research centres and start-up companies. This is a great opportunity to see how EU R&D and project funds are being used by some of the great young innovators in Europe.

A window on creative products developed by universities and research centres. Under the patronage of the European Commission, fifteen entrants from across Europe compete to win categories ranging from Best Marketability to Best Design, Best Technology, and Best Overall Product.

Join us for the Photonics Innovation Village Awards 2008 which will take place on Wednesday, 9th April 2008, from 17.00 hrs. in the Galerie de Marbre.



*Under the patronage of the
European Commission, Photonics Unit*

Co-Sponsored by:



Low power remote sensing system

Y. A. Polkanov, Russia (Individual work)

New approach is based on use of a low-power radiation source with specified gating, when time of source radiation interruption is equal to a pulse duration of ordinary lidar. We propose to reconstruct the average values of these characteristics over the parts commensurable with the sounding path length. As scanning systems is offered with speed of circular scanning is determined by time of small linear moving of a laser beam. It allows to predict a reduction of the meteorological situation stability from an anticipatory change of the revealed structure character of optical heterogeneities of a atmosphere ground layer atmosphere.

Point of care sensor for non-invasive multi-parameter diagnostics of blood biochemistry

Belarusian State University, Belarus; Ruhr-Universität-Bochum, Germany; Second Clinical Hospital, Belarus

Compact fibre optical and thermal sensor for noninvasive measurement of blood biochemistry including glucose, hemoglobin and its derivatives concentrations is developed as a prototype of the point-of-care diagnostic devices for cardiologic, tumour and diabetic patients. Integrated platform for data acquisition, data processing and communication to remote networks has been developed on the pocket PC.

Polarization-holographic gratings and devices on their basis

Laboratory of Holographic Recording & Processing of Information, Institute of Cybernetics, Georgia

We have developed the technology of obtaining of polarization-holographic gratings that have anisotropic profile continuously changing within each spatial period and also the technology of obtaining of polarization-holographic elements on the basis of such gratings. Special highly effective polarization-sensitive materials developed by us are used for obtaining such gratings and elements. We can present samples of gratings and elements and give a demonstration of their work.

Ultra-miniature omni-view camera module

Image Sensing group of the Photonics Division of CSEM (Centre Suisse d'Electronique et de Microtechnique), Switzerland

A live demonstration with a working prototype of a highly integrated ultra-miniature camera module with omni-directional view dedicated to autonomous micro flying devices is presented.

Femtosecond-pulse fibre laser for microsurgery and marking applications

Multitel, Belgium

Multitel presents a new prototype of an all-fibred femtosecond amplified laser. The device has been specifically developed for micromachining and microsurgery applications and operates at 1.55 μm , which corresponds to a high absorption peak of water (molecule contained in large quantity in living tissue and cells). Since no free-space optics is used for pulse compression or amplification the prototype is compact and very stable. Moreover, the seed laser source has a high repetition rate therefore enabling multiphoton absorption applications and use in multi-pulse and burst modes.

Flexible artificial optical robotic skins

Department of Applied Physics and Photonics (VUB-TONA) and Robotics & Multibody Mechanics Research Group (VUB-R&MM) of the Vrije Universiteit Brussel, Belgium; Thin Film Components Group (UG-TFCG) and Polymer Chemistry & Biomaterials Research Group (UG-PBM) of the Universiteit Gent, Belgium

We will present a paradigm shifting application for optical fibre sensors in the domain of robotics. We propose fibre Bragg gratings (FBGs) written in highly-birefringent microstructured optical fibres integrated in a flexible skin-like foil to provide a touch capability to a social pet-type robot for hospitalized children named "Probo". The touch information is complementary to vision analysis and audio analysis and will be used to detect where Probo is being touched and to differentiate between different types of affective touches such as tickling, poking, slapping, petting, etc.

3D tomographic microscope

Lauer Technologies, France

The 3D tomographic microscope generates 3D high-resolution images of non-marked samples. The demonstration will show 3D manipulation of images obtained with this microscope.

Polar nephelometer

Institute of Atmospheric Optics of Tomsk, Russia

Material comprising a matrix, apatite and at least one europium composite compound with particle medium sizes more 4-5 micron. The composition for the production of the material comprises (wt. %) apatite 0.01-10.0; composite compound. 0.01-10.0, and the balance is a matrix-forming agent, such as a polymer, a fibre, a glass-forming composition, or lacquer/adhesive-forming substance.

High speed Stokes portable polarimeter

MIPS Laboratory of the Haute Alsace University, France

The implementation of an imaging polarimeter able to capture dynamic scenes is presented. Our prototype is designed to work at visible wavelengths and to operate at high-speed (a 360 Hz framerate was obtained), contrary to commercial or laboratory liquid crystal polarimeters previously reported. It has been used in the laboratory as well as in a natural environment with natural light. The device consists of commercial components whose cost is moderate. The polarizing element is based on a ferroelectric liquid crystal modulator which acts as a half-wave plate at its design wavelength.

Diffraction/refractive endoscopic UV-imaging system

Institut für Technische Optik (ITO) of the University of Stuttgart, Germany

We present a new optical system with an outstanding high performance despite of demanding boundary conditions of endoscopic imaging to enable minimal invasive laser-based measurement techniques. For this purpose the system provides a high lens speed of about 10 times the value of a conventional UV-endoscope, a multiple broad band chromatic correction and small-diameter but wide-angle access optics. This was realized with a new design concept including unconventional, i.e. diffractive components. An application are UV-LIF-measurements on close-to-production engines to speed up the optimization of the combustion and produce aggregates with less fuel consumption and exhaust gases like CO₂.

Light-converting materials and composition: polyethylene film for greenhouses, masterbatch, textile, sunscreen and aerosol

Usefulsun Oy, Finland; Institute Theoretical and Experimental Biophysics Russian Academy of Sciences, Russia

The composition for the production of the material comprises (wt. %) composite compound (inorganic photoluminophore particles with sizes 10-800nm) -0.01-10.0; coordination compound of metal E (the product of transformation of europium, samarium, terbium or gadolinium) - 0,0-10,0 and the balance is a matrix-forming agent, such as, a polymer, a fiber, a glass-forming composition or gel, aerosol, lacquer/adhesive-forming substance. The present invention relates to composite materials, in particular to light-converting materials used in agriculture, medicine, biotechnology and light industry.

HIPOLAS - a compact and robust laser source

CTR AG (Carinthian Tech Research AG), Austria

The prototype covers a robust, compact and powerful laser ignition source for reciprocating gas and petrol engines that could be mounted directly on the cylinder.

We have developed a diode pumped solid-state laser with a monolithic Neodymium YAG resonator core. A ring of 12 high power laser diodes pumps the resonator. Due to the adjustment-free design, the laser is intrinsically robust to environmental vibrations and temperature conditions. With overall dimensions of $\approx 50 \times 70$ mm the laser head is small enough to be fitted at the standard spark plug location on the cylinder head. The dimensions can be reduced for future prototypes.

OLLA OLED lighting tile demonstrator

OLLA project-consortium

OLED technology is not only a display technology but also suited for lighting purposes. The OLLA project has the goal to demonstrate viability of OLED technology for general lighting applications. The demonstrator tile shown here combines the current results of the project : a large sized (15x15cm²) white OLED stack with high efficacy (up to 50 lm/W), combined with long lifetime (>10.000 hours).

During Photonics Europe, we will show several OLEDs tiles in different colors. The demonstrators are made by the OLLA project-consortium members. The large OLED demonstrator tile was fabricated on the inline tool at Fraunhofer IPMS in Dresden.

Analyze-IQ

Nanoscale Biophotonics Laboratory, School of Chemistry, and Machine Learning / Data Mining Group, Department of Information Technology, National University of Ireland, Galway, Ireland

Analyze-IQ is the next generation spectral analysis software tool for optical and molecular spectroscopies such as Raman, Mid-IR, NIR, and Fluorescence. The Analyze-IQ software is based on patented machine-learning algorithms and a model based approach in which the software learns to recognise the relevant information in complex mixtures from sample spectra. It then uses these models to rapidly and accurately identify or quantify unknown materials such as narcotics and explosives, in complex mixtures commonly found in law-enforcement and industrial applications.

Micro-optical detection unit for lab-on-a-chip

Department of Applied Physics and Photonics (VUB-TONA) of the Vrije Universiteit Brussel, Belgium

We present a detection unit for fluorescence and UV-VIS absorbance analysis in capillaries, which can be used for chromatography. By using a micro-fabrication technology (Deep Proton Writing) the optics are directly aligned onto the micro-fluidic channel. This integration enables the development of portable and ultimately disposable lab-on-a-chip systems for point-of-care diagnosis. We will explain the working principle of our detection system in a proof-of-concept demonstration set-up while focusing on some specific applications of micro-fluidics in low-cost lab-on-a-chip systems.

 SPIE Europe

Photonics Europe

Conference papers are published
at the speed of light.

 SPIE
Digital Library

Your Trusted Source for the Science
and Applications of Light

Special Events

ACCORD Project Presentations

Salon Leicester

Thursday 10 April 14.00 to 17.00
ACCORD is the Advanced Components Cooperation for Optoelectronics Research and Development - an experimental programme funded under the Sixth Framework Programme of the European Union (IST-2005-2.5.1, Photonic Components).

ACCORD's purpose is to:

- Purchase at marginal cost pre-competitive photonic devices from innovative world wide companies and
- Put them in the hands of European researchers and students, at no net cost to the university or to the company that furnished the devices

This seminar will consist of presentations from the successful participants from the 1st Round of awards. It will demonstrate the advantages to companies and Universities of engaging with the programme.

Recruitment Corner

Sponsored by:



Local Universities have been encouraged to post their vacancies at the Recruitment Corner.

In addition to university vacancies, be sure to check out www.SPIEWorks.co.uk for jobs posted by Photonics Europe exhibitors.

SPIEWorks, the SPIE job site, was developed to serve the career needs of optics and photonics professionals. Whether you are actively seeking a new position or just want to keep track of the scientific job market, you can search by region, technology, and keywords, set up email alerts or RSS feeds, and research companies of interest. SPIEWorks is here to serve you.

European Photonics Clusters Meeting

Location: Arp 2

Thursday 10 April 2008 09.30 to 17.00

Rhenaphotonics Alsace and the Photonics Unit of the European Commission's DG INFSO, in cooperation with SPIE Europe, are organising a meeting on 10 April 2008 of the photonics clusters across Europe.

The purpose of the meeting is for us all to get to know one another better and also to introduce the various players in the photonics field, learn about ongoing research activities and funding opportunities, exchange best practices, present the Photonics²¹ technology platform, and address other issues which are of interest. A workshop will also be held to explore the needs of the clusters' members for technical support and access to advanced research facilities, so that these can be better addressed in future national and European research programmes.

PROGRAMME:

- 09:30 Registration
- 10:00 Introduction
Short presentation of the meeting and its goals
- 10:10 Clusters presentation
- 11:30 European Clusters - the story so far: Overview and experiences, discussion
- 12:30 Lunch
- 14:30 Photonics²¹ presentation
- 14:50 EU actions and photonics clusters: EU photonics activities
- 15:10 Workshop / discussion: Support at regional/national/EU level for clusters and their members
- 16:30 Conclusions and wrapping up
- 16:45 Close and reception



Photonics Europe

Conference papers are published at the speed of light.



Your Trusted Source for the Science and Applications of Light

You R&D partner to develop the components of your cutting-edge systems

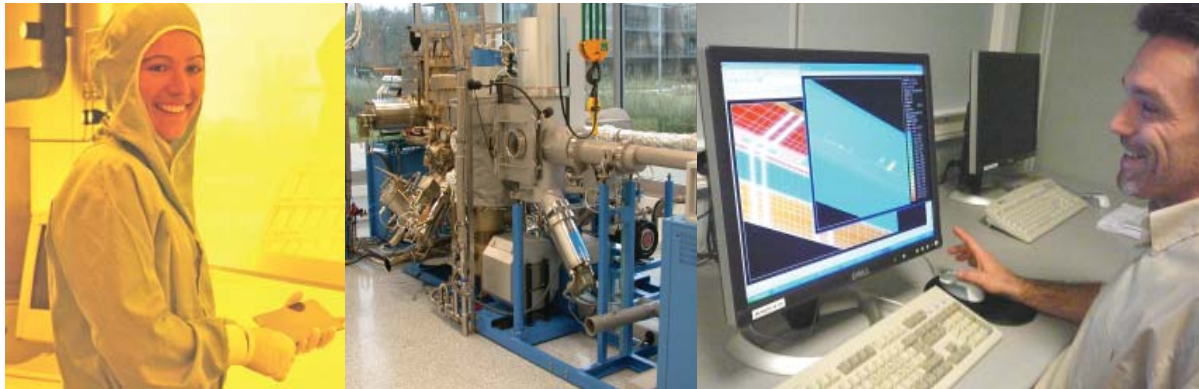

A high tech platform dedicated to the growth of III-V semiconductors, design and fabrication of opto- & microelectronic components.



Infrared lasers and photo-detectors for telecommunication, imagery, counter-measures and detection of toxic gazes.

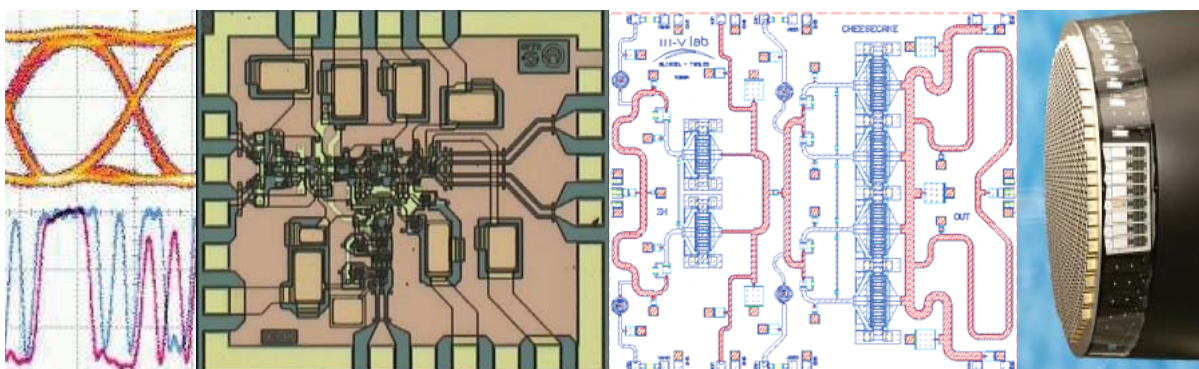

GaN and InP integrated circuits for radars and high bit rate communications.

Alcatel-Thales III-V Lab
Route de Nozay
91460 Marcoussis, France

www.3-5lab.fr

Product Tutorials

SPIE Product Tutorials give you the opportunity to get training on the latest software and tools—direct from the vendor.

See SPIE Europe Cashier to register.

Raman Spectroscopy and Spectroscopic Ellipsometry

Presented by **HORIBA** **JOBIN YVON**

Location: Salon Leicester

Wednesday, April 9 · 09.00 to 12.00

Attend this tutorial to find out the latest on Raman spectroscopy and spectroscopic ellipsometry. Specific topics include:

- New techniques in Raman microscopy and fast imaging
- Discover more about your thin film coatings with the new generation of automatic ellipsometers

Tutorial Presenters

Tutorials will be presented by HORIBA Jobin Yvon experts to ensure the best quality answers to all your questions.

For more information:

www.jobinyvon.com/photonicseurope2008

Optical Sensing

Sponsored by **SphereOptics**, **SensL** and **Avantes**

Palais de la Musique et des Congrès,
Salons Arp 3 and Arp 5

Friday, April 11 · 08.30 to 17.00

Registration Fee

20,00 Euro, includes lunch and tutorial materials

Tutorial agenda available on-line at:

www.sphereoptics.com

www.avantes.com

www.sensl.com

Industry technology experts from SphereOptics, SensL and Avantes will present a full-day Optical Sensing Product Tutorial. Attendees will learn design fundamentals and applications methods, along with hands-on workshops to discuss various optical sensing issues.

Presentation Tutorials include:

- basics of light radiometry and photometry
- techniques for spectroscopic analysis
- low light detection solutions

PLUS information on how to:

- specify an integrating sphere
- select and configure the right spectrometer
- choose the appropriate low light detector

Who should attend?

The lectures and seminars are intended for scientists and engineers working in the field of optical sensing including light measurement, testing of optical properties of materials, color measurement, spectroscopic measurement techniques and evaluation and testing of photon counting as it relates to low light level sensing and semiconductor device physics.

Practical and Hands-on Demonstrations

Practical demonstrations for a variety of integrating spheres measurements and spectrometers applications will be shown. Attendees will have the ability for hands-on use of instruments. Ample time is allotted in a separate demonstration room to discuss your needs with the tutorial presenters.

Tutorial Presenters

Chris Durell - VP Sales, Sphereoptics

Chris Durell is the VP of Sales for Sphereoptics. He has over 12 years of experience with sphere-based radiometric and optical systems design. Mr. Durell obtained his BS in Electrical Engineering at Cornell University and his MBA at Franklin Pierce College. cdurell@sphereoptics.com

Benno Oderkerk - Avantes BV

Benno Oderkerk obtained his master's degree in Electronic Engineering at the Twente Technical University in Enschede, Netherlands in 1988. He worked from 1987 to 1988 at the Technion Institute of Technology in Haifa, Israel and in Munich, Germany at the University of the Bundeswehr in 1989 as a research associate. From 1989 until 1994 he worked as a technical Director at STM Sensor Technology, Munich, Germany. Since 1994 he has been the cofounder and shareholder of Avantes, a spectroscopy company in the Netherlands with offices in the US (Broomfield, CO) and Beijing, China. At Avantes he is a technical director for new product development and oversees sales and marketing and activities worldwide. benno@avantes.com

Dr. Carl Jackson - SensL

Dr. Jackson obtained a B.Sc. and M.Sc. in Electrical Engineering from Clemson University, South Carolina. He received a Ph.D. in Microelectronic Engineering from the National University of Ireland, Cork. His research has been focused on the development of silicon low light detectors for microarrays, low cost optical immunoassay instruments, integrated microfluidic sensors, and the integration of detectors into new detection systems. Prior to SensL, Dr. Jackson founded Photon Detection Systems which focused on the design of optical detector modules. In 2004 he co-founded SensL and is the company's Chief Technology Officer responsible for SensL's product development and application of SensL's technology in customer applications. cjackson@sensl.com

Find these leading-edge companies
at the **EPIC Pavilion**
at **SPIE Photonics Europe**

• **Alcatel Thales III-V Lab**, France
booth 329
<http://www.3-5lab.fr>



• **ASML**, the Netherlands
booth 325
<http://www.asml.com>



• **Bookham**, United Kingdom
booth 317
<http://www.bookham.com>



• **CEIT**, Spain
booth 323
<http://www.ceit.es>



• **Heinrich-Hertz-Institute**,
Germany, *booth 321*
<http://www.hhi.fraunhofer.de>



• **Horiba Jobin Yvon**, France
Booth 327
<http://www.jobinyvon.fr>



EPIC Contact

Thomas P. Pearsall, General Secretary Email: pearsall@epic-assoc.com
Martine Keim-Paray Email: keim-paray@epic-assoc.com
Website: <http://www.epic-assoc.com>

Effective Technical Presentations

Tuesday 8 April 08:30 to 12:30

Course Level: Introductory · CEU: 0.35
WS897 · Price: €90 SPIE Member / €130 nonmember

Oral presentation skills are a key to success for researchers. This course proposes a five-step methodology that will take you from scratch to an effective technical presentation. It also offers tips on how to manage the nervousness associated with speaking in public.

Learning Outcomes

This course will enable you to:

- plan your presentation efficiently
- organize your material into an effective structure
- create slides that get the message across
- deliver your presentation effectively, both verbally and nonverbally
- handle even the most difficult questions

Intended Audience

This material is intended for anyone who must prepare and deliver oral presentations. Both novice and experienced speakers can expect to learn much from it.

Instructor

Jean-luc Doumont runs lectures, workshops, and training programs in oral, written, and graphical communication for engineers, scientists, and managers worldwide. He is an engineer from the University of Louvain and a doctor in applied physics from Stanford University. This course is based on his popular lecture on oral presentations at over 15 top-ranked engineering schools (MIT, Stanford U, UC Berkeley, Caltech, Harvard, etc.).

Hands-On Optics (HOO)

Making an Impact with Light: Terrific Telescopes Workshop

Tuesday 8 April 13:30 to 16:00

Course Level: Introductory · CEU: 0.25
WS852 · Price: €7 SPIE Member / €15 nonmember

This workshop will train attendees on the use of Terrific Telescopes, a hands-on activity kit intended to engage and enrich the math/science learning experience for students in the middle grades. It was developed as part of HOO, a four year program funded by a \$1.7 million dollar grant from the U.S. National Science Foundation (NSF) to design and implement a science enrichment program for children ages 11 to 14 years old.

Intended Audience

Optics professionals, university students, and pre-college teachers.

Instructor

Robert Sparks earned an M.S. in Physics from Michigan State University and is a Science Education Specialist at the National Optical Astronomy Observatory in Tucson, AZ. He taught high school physics, math and astronomy for 11 years before joining the HOO Team. He has been revising the HOO modules, planning and delivering HOO professional development workshops, and working on the development of new modules.

Registration is required.
See SPIE Cashier to Register.

Diffraction Optics Technology for Product Development In Transportation, Display, Security, Telecom, Laser Machining and Biomedical Markets

Monday 7 April 13.30 to 17.30

SC787 · Price: €230 SPIE Member / €265 nonmember
Course Level: Introductory · CEU: 0.35

Students save 50% on registration.

This course provides an introduction to product development using Diffractive Optics technology in today's established and emerging markets. It provides attendees with practical techniques to manage fabrication flows for diffractive optics using available design tools and foundries, and how to interface between them efficiently.

The course will be split into three parts:

1) After a short introduction to the diffractive optics concept, the first part of the course will focus on the various diffractive optics design and modeling tools available to an industrial product development department, and how they interface with standard optical design CAD tools and other 3D mechanical design tools in order to provide a global CAD solution for the development of real products.

2) The second part of the course will focus on the various fabrication techniques and technologies available in industry today for the mastering and mass replication of diffractive optical elements. More specifically, we will focus on how a product development manager can manage complex diffractive optics fabrication under various constraints (technology, budget, fabrication time, mass production and time to market). Emphasis will be put on design to fabrication interfacing, fabrication limitations, and fabrication costs analysis as well as fabrication flow control.

3) The third and last part of the course will focus on the various products already on the market including diffractives, and identify the potential future applications including such elements. Six application sectors will be considered in depth: Automotive and Transportation; LED and Laser Displays; Optical Security devices; Optical Telecommunications; Laser Machining and Laser Material processing; and Biomedical applications.

The attendee will therefore benefit from a concise and realistic overview of current diffractive optics technology, and thus be able to make the right decision when it comes to weighting the potentiality of using diffractive optics for a specific product development.

Learning Outcomes

This course will enable you to:

- choose the right tools for your application from the range of available options for Diffractive Optics design and modeling
- classify which fabrication tools are currently available in industry and know how to interface with them
- choose the right fabrication technology for the right performance / price ratio
- compare the limitations of each technology owing to the limitations in both design and fabrication processes
- describe where diffractive optics are applied today and where they might be applied tomorrow

Intended Audience

This course is intended for product development managers, directors of engineering, marketing managers, development engineers, or anyone who has to make decisions on why, when and how to use diffractive optics in their existing product lines and new product development programs, in order to decrease production costs, increase optical performance, or simply find new solutions to existing technological problems. No prior background in diffraction theory is needed as we will not enter into details in the modeling/simulation aspects, as it is done in many other short courses.

Instructor

Bernard Kress PhD has been involved in numerous start-ups based on diffractive optics in the Silicon Valley, California, for the past 12 years. He has supervised product development for products including diffractive optics in the telecom, automotive, display, biomedical, laser machining and optical data storage markets. He is also teaching photonics at University Louis Pasteur. He has published two books on this technology (by John Wiley and Sons and McGraw-Hill.)



7–10 April 2008
Palais de la Musique et des Congrès
Strasbourg, France

Registration

Onsite Registration Hours

Palais de la Musique et des Congrès, Erasme Foyer

Sunday 6 April	13.00 to 17.30
Monday 7 April	07.30 to 17.00
Tuesday 8 April	08.00 to 17.00
Wednesday 9 April	08.00 to 17.00
Thursday 10 April	08.00 to 16.00

Exhibition Hours

Tuesday 8 April	12.00 to 19.30
Wednesday 9 April	10.00 to 17.00
Thursday 10 April	10.00 to 14.00

Policies

Children on the Show Floor

For safety and insurance reasons, no person under 16 years old will be allowed on the exhibit floor during move-in and move-out. During open exhibition hours, only children over 12 years old accompanied by an adult will be allowed on the exhibit floor.

Photography/Video Policy

In the Exhibition Hall: For security and courtesy reasons, photographing or videotaping individual booths and displays in the exhibition hall is allowed ONLY with explicit permission from on-site company representatives. Individuals not complying with this policy will be asked to surrender their film and to leave the exhibition hall.

No Suitcasing Policy

Suitcasing is the act of soliciting business in the aisles during the exhibition or in other public spaces associated with the exhibition. Please note that while all meeting attendees are invited to the exhibition, any attendee who is observed to be soliciting business in violation of any portion of SPIE Europe Exhibition Policy will be asked to leave immediately. Additional penalties may be applied. Please report any violations you observe to show management.

Food and Beverage Services

Coffee Breaks

Tuesday, Wednesday, Thursday . . . 10.00 to 11.00 and 15.00 to 16.00
Coffee will be served during the morning and afternoon breaks in the exhibition hall.

Cash Lunches

A cash lunch buffet will be held in the Exhibition Hall, Tuesday–Thursday starting at 11.30. Lunch tickets may be purchased for €20 each from the Cashier at Registration. Cash lunches may also be purchased at the Bar Agora. Lunch can also be purchased at the surrounding hotels and restaurants.

Desserts

Exhibition Hall

Tuesday and Wednesday

Dessert snacks will be served during the afternoon coffee break. Complimentary tickets for the dessert snacks will be included in conference and exhibitor registration packets.

SPIE Europe Onsite Services

Messages for Attendees

Messages for attendees at Photonics Europe can be left by calling the Palais de La Musique et des Congrès at Tel: **+33 3 88 37 67 67**, Fax +33 3 88 35 38 17 and asking for the SPIE Europe conference registration desk. Messages will be taken during registration hours Monday through Thursday. Attendees should check the message boards at the message centre on a daily basis to receive their messages.

Internet Access/WiFi

The Internet Café will be open from Monday to Thursday during registration hours. Several internet access terminals will allow attendees to access their internet e-mail during the conference. There will be a 10-minute time limit for each internet session.

The Palais de la Musique et des Congrès also has WiFi capability. Prices at the point of going to press are: 60 minutes' access in 24 hours: €10.00; 24 hour access: €22.00; 7-day access: €88.00. Access can be purchased online by starting up your browser at the venue.

SPIE Marketplace and Membership Services

The SPIE Marketplace is your source for the latest SPIE Press books, Proceedings, and Education and Professional Development materials. Become a member of SPIE, explore the Digital Library, and take home a souvenir.

Luggage Storage and Coat Check

Convention Centre, Ground Floor near Entrée Erasme

Monday–Thursday 7.30 to 18.00

There will be a minimal cost for coat and luggage storage as required by the Convention Centre.



SPIE Europe Photonics Europe

Exhibition Hours:

Tuesday 8 April 12.00 to 19.30
 Wednesday 9 April 10.00 to 17.00
 Thursday 10 April 10.00 to 14.00

AMA Association for Sensor Technology #209

Friedlaender Weg 20, Goettingen, Germany, D-37085
 +49 551 21695; fax +49 551 25155
 info@ama-sensorik.de; www.ama-sensorik.de

Independent European non-profit association of more than 440 industrial and research organizations involved in sensor technology research, development, manufacture, distribution, services or supply, including optical methods. Activities include seminars, workshops, special interest committees, a directory of services, community stands at trade shows (AMA Sensor Centers) and hosting the SENSOR+TEST trade show with accompanying conferences, including Opto and IRS2. Contact: Thomas Simmons, General Secretary.

A.T. Wall Company #224

55 Service Ave, Warwick, RI, 02886
 401/739-0740; fax 401/732-5784
 sales@atwall.com; www.atwall.com

AFOP - French Optics and Photonics Manufacturers Association #124

185 rue de Bercy, Paris cedex 12, France, F-75579
 +33 1 43 46 57 50; fax +33 1 43 46 27 58
 www.gjfo.org

French Optics and Photonics Manufactures Association (AFOP) is a trade association dedicated to photonics professionals for the promotion and the defense of the industry interests in France and aboard: exhibitions, market survey, business intelligence, bulletin of bids for tender, delegation in the standardization committee(s). Contact: Ivan Testart, AFOP Manager, ivan.testart@gjfo.org.

AHF analysentechnik AG #316

Kohlplattenweg 18, Tuebingen, Germany, 72074
 49 7071 83203; fax 49 7071 83203
 info@ahf.de; www.ahf.de

New Product: Laser filters with extreme performance, hardcoated multiphoton filters, metalhalide light source.

With more than 15 years experience in assembling of optical filters AHF analysentechnik provides spectral solutions for life sciences analysis like single-/multiphoton resp., singlemolecule fluorescence, STED, Raman, CARS. Individual optical set-ups will be provided in cooperation with Semrock, Inc. and Chroma Corp. AHF analysentechnik will guarantee best optical performance according to the customers' demands. Contact: Michael Sommerauer, Sales Director, ms@ahf.de; Ingrid Feuerbacher, Andreas Braunwarth.



AHF our experience—your profit in optical filters!

Alcatel Thales III V Lab #329

Route de Nozay, Marcoussis, France, 91460
 +33 1 3077 68 93; fax + 33 1 30 77 67 86
 www.3-5Lab.fr

New Product: QWIP and InGaAs Focal Plane Arrays, IR laser diodes and QCLs, InGaAs PINs and APDs, epitaxial wafers.

Alcatel Thales III-V Lab is an industrial R&D organization jointly owned by Alcatel-Lucent and Thales. Its purpose is to perform research and development on III-V compound semiconductor components, from basic research to pilot line production, for applications addressed by Alcatel-Lucent and Thales, telecom, space, defense and security, as well as for other applications such as environment and health-care. Current products include QWIP Focal Plane Arrays, InGaAs photodiodes, mid-infrared lasers. Contact: Denis Mazerolle, Business Development Executive, denis.mazerolle@3-5lab.fr.

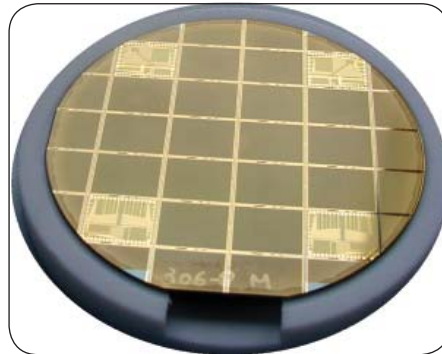

Processed wafer: infrared focal plane arrays.

AT-Fachverlag GmbH #534

Saarlandstr 28, Fellbach, Germany, 70734
 49 711 952 9510; fax 49 711 952 95199
 at@at-fachverlag.de; www.photonik.de

New Product: Photonik international Trade Journal on Optical Technologies.

Photonik international issues are English specials of the German-language magazine Photonik. 20 selected technical articles from the 2007 issues each, translated into English, provide a broad overview of current knowledge in Optical Technologies worldwide. Contact: Norbert Schöne, Marketing Manager, schoene@at-fachverlag.de.



Photonik international: Trade Journal on Optical Technologies

Exhibition Directory

Avantes

#232

Soerensezand 4A, Eerbeek, The Netherlands, NL-6961 LL
31 313 670170; fax 31 313 370179
info@avantes.com; www.avantes.com

Avantes, a leading company in the field of fiber optic spectroscopy, now offers the possibility of Store to RAM. This new feature makes it possible to store a high amount of spectra in a very short time. These spectra are saved in the internal memory (RAM) of the spectrometer before they are sent to the PC. Implementation of the Store To RAM function, which allows the storing of scans at high speed (as fast as 1.1. msec per scan for the AvaSpec-2048-USB2, and 0.1 msec per scan for the AvaSpec-128-USB2) in the spectrometer, without the overhead of USB communication. Contact: Caroline Bach, Marketing Coordinator; Peter Hiddinga, Sales Engineer.

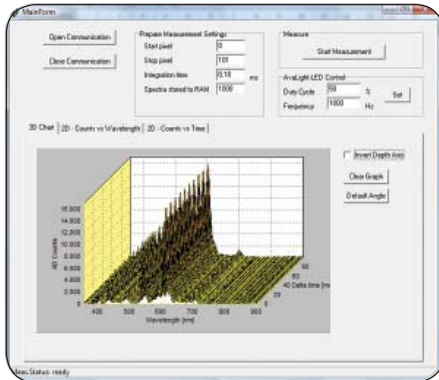

Typical 3D spectral graph of a fluorescence lamp.

Becker & Hickl GmbH

#405

Nahmitzer Damm 30, Berlin, Germany, D-12277
49 30 787 5632; fax 49 30 787 5734
info@becker-hickl.de; www.becker-hickl.de

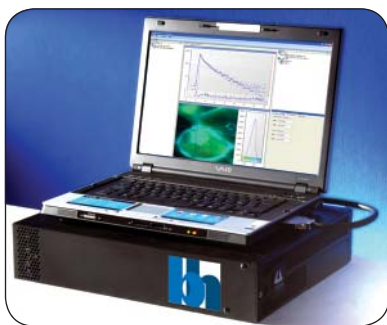

SimpleTau compact high-performance fluorescence lifetime systems

Bookham

#317

Binzstrasse 17, Zurich, Switzerland, 8045
41 44 455 85 85; fax 41 44 455 85 86
highpower@bookham.com; www.bookham.com

New Product: 10W 9xxnm Fiber Laser Pump Module, 1060nm Seed-Module with FBG; High Efficiency 808nm Products; Very High Brightness 9xxnm Bar: 80W from a 3.2mm emitting Area.

Bookham's world-class Swiss facility has been producing industry leading laser diodes for more than 20 years. Proprietary core technologies like the E2 mirror passivation process deliver both highest brightness and outstanding reliability. Our products, from single emitters to bars and arrays, are designed for the most demanding applications in industrial, medical, printing, display and defense. Contact: Pierre-Alain Champert, Technical Sales Engineer, pierre.champert@bookham.com; Gunnar Stolze, Director Sales, gunnar.stolze@bookham.com.



MeVis-C

High performance lens to meet highest requirements



- Excellent resolution
- C-mount
- For Vis and NIR
- Suitable for 3-CCD



- Motorized version available

New

The new complete catalog is available. **Get your copy now. Phone / Web or directly at our booth (307).**

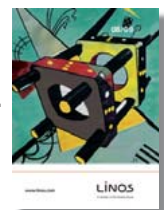

SPIE Europe

Booth 307

LINOS Photonics France

90, avenue de Lanessan
69410 Champagne au Mont d'Or
Tel. +33 (0)4 72 52 04 20
Fax. +33 (0)4 72 53 92 96
E-mail: info-fr@linos.com

LINOS

A member of the Qioptiq Group

Breault Research Organization

#117

SPIE Corporate Member

6400 E Grant Rd Ste 350, Tucson, AZ, 85715-3862
800/882-5085; fax 520/721-9630
info@breault.com; www.breault.com

New Product: ASAP 2008 - Next-generation interoperability, polarization modeling and optimization.

BRO's optical software products help engineers turn creative visions into working prototypes and the company's own engineers work on beyond-state-of-the-art projects for enterprise companies, research institutions and top government labs. In over three decades of innovation, BRO has contributed to the success of engineering projects for thousands of clients. Contact info@breault.com for information concerning BRO's software products and engineering services. Contact: Donna Hart, Global Sales Manager, dhart@breault.com; Dr. Bernhard Michel, ASAP Representative, Germany, info@simuloptics.de.



Breault Research releases the next-generation of ASAP.

Brush Ceramic Products

#104

6100 S Tucson Blvd, Tucson, AZ, 85706
520/746-0251; fax 520/294-8906
sales@brushceramics.com; www.brushceramics.com

New Product: New BW3250 conducts heat at 325W/mK!

Be cool with BeO ceramic. Brush Ceramic Products is the leading manufacturer of Beryllium Oxide Ceramics. BeO ceramics in laser technology enables optoelectronics to operate at higher temperatures in small, highly reliable packages. BeO provides thermal conductivity second only to diamond among electrically insulating materials, dissipating over 300W/mK at room temperature. BeO's thermal conductivity is ten times greater than Al₂O₃ ceramics and double AlN. Standard or custom configurations. Contact: Lee Vandermark, Sales and Marketing Manager, lee_vandermark@brushceramics.com.

Carl Hanser Verlag

#530

Kolbergerstr 22, Muenchen, Germany, 81679
49 89 99830 0; fax 49 89 99830 623
info@hanser.de; www.hanser.de

Cedrat Technologies

#118

15 Chemin de Malacher - Inovallée, Meylan cedex,
France 38246
+33 4 76 90 50 45; fax +33 4 56 38 08 30
cedrat@cedrat.com; http://www.cedrat-groupe.com

New Product: Microscanning stage for increasing resolution of IR/visible CCD and CMOS detectors.

Cedrat Technologies is a high tech SME of Cedrat group and is specialised in mechatronic engineering. Micro & nano positioning, fast & precise actuation, generation & active control of vibrations, active & adaptive optics, fast tool servo, micro-scanning, fast shutters. CEDRAT TECHNOLOGIES owns unique technologies of low-voltage piezo-actuators, piezo-transducers and piezo-motors. These technologies are patented and innovative according to the patent search reports. Piezoelectric devices are both available as off-the-shelf products and as customised products. CEDRAT TECHNOLOGIES also masters several technologies of low-power electromagnetic rotating and linear drives, including their control/command and their power supply. Contact: Thomas Maillard, Sales Engineer, thomas.maillard@cedrat.com.

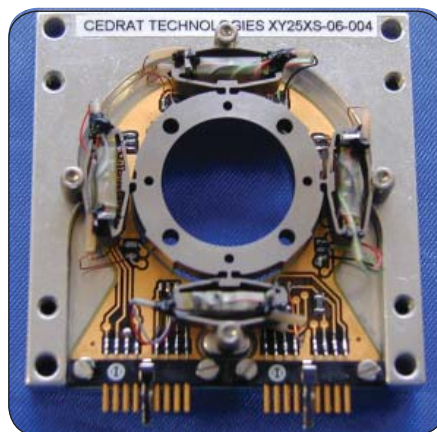

Microscanning stage for increasing resolution of IR/visible camera detector.

CEIT

#323

Paseo Manuel Lardizabal 15, San Sebastian, Spain, 20018
+34 943 212 800; fax +34 943 213076
www.ceit.es

New Product: Laser interference lithography system that can define nanopatterns with resolutions down to 100 nm.

Research center dedicated to the development of MOEMS and new process technology for MOEMS. Contact: Santiago Miguel Olaizola, yolaizola@ceit.es; Ainara Rodriguez, airodriguez@ceit.es.

CILAS

#416

8 avenue Buffon - ZI La Source, Orleans, France, F-45063
33 2 38 64 59 02; fax 33 2 38 64 59 07
optics@cilas.com; www.cilas.com

New Product: Prototypes to Large series Optical Components Thin Film Coatings Optical Systems Adaptive Optics.

For over 40 years, CILAS has been at the leading edge of the modern technology sector thanks to its unique expertise in LASER and OPTRONICS technologies. CILAS shareholders are EADS and AREVA. With a 30 M€ turnover in 2007, CILAS addresses the following markets: Defence and Security, Space, Astronomy, Scientific, Medical, Industry. Contact: PALOMO Richard, Sales and Contract Manager, palomo@cilas.com; VIARD Priscilla, Sales Engineer, viard@cilas.com.

Exhibition Directory

Conerefringent Optics SL #508

Avda Cubelles 28, Vilanova i la Geltru,
Barcelona, 08800
+34 93 815 6839
sales@croptics.eu; www.croptics.eu

New Product: Elements for conical refraction.

Conerefringent Optics SL was registered in 2006 with a principal aim development and production of elements for conical refraction. The destinations of the products are universities and research photonics labs. Contact: Maria Atanasova, Sales.

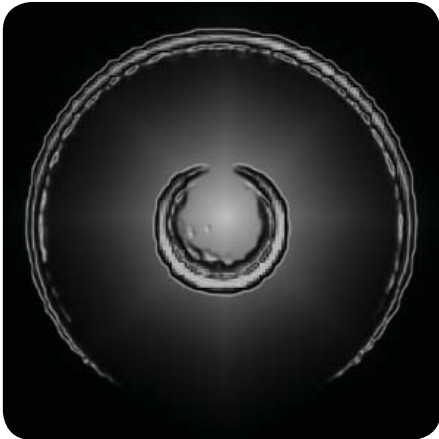

Our products make the Conical Refraction effect at work.

Crystal Fibre #306

SPIE Corporate Member

Blokken 84, Birkerød, Denmark, DK-3460
45 4348 2800; fax 45 4348 2801
contact@crystal-fibre.com; www.crystal-fibre.com

New Product: 350 W CW fiber laser module for OEM integration.

Crystal Fibre design, develop and manufacture advanced specialty fibers based on our photonic crystal fiber technology. Products include CW laser and amplifier assemblies based on all-glass double clad fibers. The highly reliable airclad fibers and combiners provide the basis for high power handling and excellent beam quality. Other specialty fibers include polarizing, polarization maintaining, photosensitive, single mode high power cables and supercontinuum versions. Contact: Rene Kristiansen, Sales Manager, rek@crystal-fibre.com.



CW fiber laser module—350 W for OEM integration.

KLASTECH

KARPUSHKO LASER TECHNOLOGIES

Single longitudinal mode laser systems

Highlights@Photonics Europe 2008

Booth 420

1 W / 532 nm SLM

3 W / 1064 nm SLM

Technology

- SLM and low noise operation
- Highly efficient frequency conversion
- No mode hops
- Covers spectrum from UV to middle IR
- Scalable CW output power from 10's mW to over 10 W

Products

- Laser series 442 nm / 532 nm / 1064 nm
- Under development 355 nm / 266 nm



Applications

CD mastering, confocal microscopy, digital film processing, ellipsometry, flow cytometry, holography, interferometry, metrology, molecular biology, printing, reprographics and others.

Find out more at www.klastech.de

KLASTECH - Karpushko Laser Technologies GmbH
Konrad-Adenauer-Allee 11, D-44263 Dortmund, Germany, info@klastech.de

Exhibition Directory

CST - Computer Simulation Technology #226

Bad Nauheimer Str. 19, Darmstadt, Germany, 64289
+49 6151 7303 0; fax +49 6151 7303 100
Info@cst.com; www.cst.com

CST develops and markets software products for the simulation of electromagnetic fields in all frequency bands. CST MICROWAVE STUDIO (CST MWS) is the market leading time domain tool for 3D EM simulation. Embedded in CST DESIGN ENVIRONMENT, it can be coupled with all CST STUDIO SUITE solver technology including circuit and thermal simulation. More information can be found at www.cst.com.

CVI Melles Griot Ltd. #507

Second Ave, Onchan, Isle of Man, United Kingdom, 1M3 4PA
44 1624 647 000; fax 44 1624 676 859
sales@tol-cvi.com; www.cvilaser.com

New Product: 4000 uncoated substrates + 2500 coating options = 2 week delivery at a catalog price.

CVI Melles Griot gets you what you need, when you need it. From the UV to the IR we offer unmatched breadth and flexibility in lasers, optical components and electro-optical assemblies. Our extensive catalog, along with our custom and build-to-print capabilities deliver solutions from prototype to high-volume, OEM quantities. We are your single-source for solutions for semiconductor, biotechnology, industrial and basic research applications. Contact: Francis Tack, ftack@cvmellesgriot.com; Chris Bridle, cbridle@cvmellesgriot.com.

Draka #230

Parc Des Industries Artois Flandres, Billy Berclau, Haisnes Cedex, France, 62092
+33 3 2179 49 00; fax +33 3 2179 49 19
www.draka.com

New Product: Optical fibre specialty products.

Draka, headquartered in Amsterdam, the Netherlands, is a € 2.5 billion, publicly listed (Euronext) company with 9,145 employees worldwide. Draka handles the production and sale of optical fibre and specialty optical fibre products as well as low-voltage and special purpose cable. Draka is a global leader in optical fibre technology and cabling solutions, with a comprehensive suite of network design and engineering services. For more information please visit www.draka.com. Contact: Patrick Bourghelle, Specialty fibre Sales Manager, patrick.bourghelle@draka.com; Aurelien Bergonzo, Specialty fibre product line manager, aurelien.bergonzo@draka.com.

EDP Sciences #532

17 Ave du Hoggar, Courtaboeu Les Ulis Cedex, France, F-91944
33 169 187 575; fax 33 169 288 499
edps@edpsciences.org; www.edpsciences.org

EKSPLA Co. #330

SPIE Corporate Member

Savanoriu Av. 231, Vilnius, Lithuania, 2300
+370 5 264 96 29; fax +370 5 264 18 09
sales@eksma.com; www.eksma.lt

New Product: PL10100 series DPSS ultrafast picosecond laser for micromachining and other processing applications.

EKSPLA is a manufacturer of solid state lasers and photonics components. Mode-locked picosecond Nd:YAG lasers, q-switched nanosecond Nd:YAG lasers, broadly tunable OPO/OPG systems and THZ spectroscopy equipment are available. NT340 series nanosecond Q-switched tunable wavelength laser system features offers hands-free no gap wavelength tuning from 210 to 2300 nm. Components include nonlinear and laser crystals, laser optics, opto-mechanics, crystal ovens with controllers, pulsed power supplies. Contact: Sokas Sulcas, Lasers and laser systems sales manager (Europe), r.sulcas@ekspla.com; Daugirdas Kuzma, Photonics components Sales Manager, d.kuzma@ekspla.com.



PL10100 series picosecond DPSS laser for micromachining applications.



EXHIBITOR LOUNGE SPONSOR

Electro Optics Magazine #430

27 Queen Sq, Bristol, United Kingdom, BS1 4ND
44 117 929 2505; fax 44 117 929 2505
sales@europascience.com; www.europascience.com

Electro Optics is the number one magazine for Europe's photonics market. If you need to do business in Europe, no other magazine is better positioned or better able to help you achieve your goals. Contact: Dominic Light, Business Development Manager, dominic.light@europascience.com; Alex Sullivan, Publishing Director, alex.sullivan@europascience.com.

EPIC: European Photonics Industry Consortium #331

17 Rue Hamelin, Paris, France, F-75016
33 1 45 05 72 63; fax 33 1 45 05 72 63
www.epic-assoc.com

New Product: EPIC provides personalized services in technology and marketing for its members.

EPIC is an independent association with a mission to build sustainable growth for European Photonics Industries. We execute our mission by:
1. Creating, developing or supporting business opportunities involving our members;
2. Providing our membership with timely information concerning technology developments, market opportunities, access to R&D resources;
3. Facilitating access to resources for technology research and development, for innovation and for product engineering.
Contact: Thomas Pearsall, General Secretary, pearsall@epic-assoc.com; Martine Keim-Paray, Member of Staff, keim-paray@epic-assoc.com.



European Photonics Industry Consortium.

ePIXnet

#431

INTEC, St Pieters Nieuwstraat 41, Gent, Belgium, B-90000
ePIXnet.secr@intec.UGent.be; www.epixnet.org

The ePIXnet silicon photonics platform provides cost-sharing access to high-end CMOS facilities for wafer-scale research and prototyping of silicon photonic integrated circuits. User designs are processed together on 200mm wafers. The 193nm deep UV lithography supports large-scale photonic integration based on submicron silicon photonic structures. By sharing the mask and processing in regularly announced processing runs, the cost per user is affordable for all. Contact: Pieter Dumon, Platform Coordinator, Pieter.Dumon@imec.be.

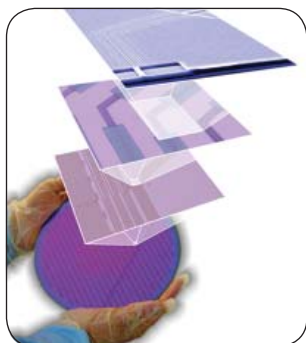

Wafer-scale prototyping of silicon photonic integrated circuits.

Epner Technology, Inc.

#423

78 Kingsland Ave, Brooklyn, NY, 11222-5603
718/782-5948; fax 718/963-2930
epner78@aol.com; www.epner.com

Electroformed cold shields, custom designed infrared lightpipes, laser pump cavity reflectors, Laser Gold®, the NIST infrared standard achieves theoretically low emissivity and Laser Black® which "swallows light", plus a broad range of electroplating, optical fabrication and coating technologies. Contact: David Epner, President, david@epner.com; Paul Brancato, General Manager, paul@epner.com.



Laser Gold® coating on a diamond turned compound parabolic concentrator.

EQ Photonics GmbH

#223

Obere Hauptstrasse 30, Eching, Germany, 85386
+49 (0)89 31 90 19 - 0; fax +49 (0)89 31 90 19 - 49
info@eqphotonics.de; www.eqphotonics.de

Acousto-optic filters; modulators, deflectors; Q-switches; RF drivers; laserlamps; LN-, PPLN-, MgO:LN crystals; fiber optic components and systems; high-power diode lasers, VIS and IR-High power LEDs; Si- and InGaAs-Photodiodes; Thermoelectric modules.

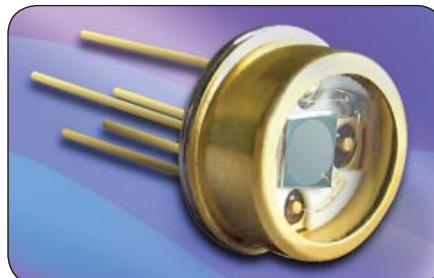

New NIR-Photodiode-Preamplifier from Opto Diode, - available now ! Visit EQ Photonics GmbH booth no. 223.

ET Enterprises Ltd

#328

Bury St, Ruislip, Middlesex, United Kingdom, HA4 7TA
44 (0) 1895 630773; fax 44(0) 1895 631774
info@electron-tubes.co.uk; www.electrontubes.com

New Product: A new range of ultra-low temperature photomultipliers designed for use in Astrophysics.

ET Enterprises is now manufacturing and supplying the range of photomultipliers from the former Electron Tubes Ltd. The company also supplies light detection system hardware such as amplifiers, photon counting modules and photomultiplier housings. Contact: Ron Stubberfield, Director of Sales; Graham Sperrin, Europe Sales Manager.



ADAPTIVE OPTICS APPLICATIONS

SPACE LIGHT srl
Space Light srl is an Italian SME involved in the realization of custom optical systems.
Space Light is specialized in the application of adaptive optics techniques and technologies in various fields, including free space optical communications, intra-cavity wavefront control, laser beam size control.

CUSTOMERS
Astronomical Observatory of Padua, PRIMA Industrie SpA, Salvagnini SpA, Thales Alenia Space, ASI, ESA, CISAS, Alta Space SpA

AWARDS
In 2007 Space Light srl has been awarded the Bepi Colombo Prize for its contribution to the application of adaptive optics to industry (for more information see www.bepicolomboprize.org).

CONTACTS
Vie. Combattenti Alleati d'Europa 9/G
45100 Rovigo - Italy
www.spacelight.it - info@spacelight.it
Phone 0039 0425 471055
Fax 0039 0425 471095

Exhibition Directory

European Optical Society

#536

Hollerithallee 8, Hannover, Germany, 30419
49 511 2788155; fax 49 511 2788119
nowitzki@myeos.org;

The European Optical Society (EOS) serves as the joint forum for all individuals, companies, organizations, educational institutions and learned and professional societies. Organizes Topical Meetings and sponsors other scientific meetings. Publishes the electronic Journal of the European Optical Society Rapid Publications (JEOS:RP); is continuously working to establish collaboration or coordination agreements with other learned societies active in optics and related sciences. Contact: Petra Bindig, Marketing and Communications, bindig@myeos.org; Judith Herzog, Event and Account Management, Herzog@myeos.org.

EuroPhotonics

#100

2 South St, Berkshire Common, Pittsfield, MA, 01201
413/499-0514; fax 413/442-3180
photonics@laurin.com; www.photonics.com

EuroPhotonics magazine provides accurate, readable and up-to-the-minute information about photonic products available in the European marketplace. Its focus is strongly European and its content covers photonics technologies from conventional optics and electro-optics to lasers, fibre optics and imaging. Published bi-monthly, it is distributed free to readers in Europe and Israel who use or apply photonics. Contact: Penny Pretty, Regional Manager, advertising@laurin.com.

Fibercore Ltd.

#515

+44(0) 23 8076 9893; fax +44(0) 23 8076 9895
info@fibercore.com; www.fibercore.com

Fibercore Limited, as the World's leading supplier of Specialty Singlemode Fibres, has more than 26 years experience exclusively dedicated to the design, manufacture and commercialization of specialty fibres. Whether you require Polarization Maintaining, Bend-Insensitive, Rare-Earth Doped, Cladding-Pump or Photosensitive fibre, Fibercore Limited has the expertise and experience necessary to not only meet, but exceed all your expectations and requirements. Contact: Wendy Stewart, Sales Administrator, wendy.stewart@sciatl.com; Simon Vargeson, Senior Sales Engineer, simon.vargeson@sciatl.com.

Fibercryst

#426

La Doua - Bat l'Atrium, Boulevard Latarjet,
Villeurbanne Cedex, France, 69616
33 688 023 226; fax 33 426 689 874
contact@fibercryst.com; http://www.fibercryst.com

FIBERCRYST produces single crystal fibers, tubes and shaped crystals for laser, high energy radiation detectors and sapphire applications. The high and unique properties of single crystal materials are now available for any application that requires long length of crystal (up to 1 meter!), light guiding properties and thin diameters (down to 0.2 mm). FIBERCRYST also provides general optics, laser crystals, non linear optics, polarization optics.

FiberTech Optica Inc.

#415

SPIE Corporate Member

330 Gage Ave Ste 11, Kitchener, ON, Canada, N2M 5C6
519/745-2763; fax 519/576-0007
jeffdup@fto.ca; www.fibertech-optica.com

New Product: Imaging fiber arrays with up to 25x25 fused silica fibers (minimum core diameter 100um) available.

Designer and manufacturer of specialty multimode silica fibers optic assemblies. Featuring high power laser cables, patchcords, pigtailed, spot-to-line converters, bundle, reflectance probes, vacuum feedthrough, linear and spaced v-groove arrays, imaging arrays. Spectral bands coverage from deep UV to MIR. Core diameters 10 to 2000um. Contact: Jeff Dupuis, Sales and Marketing Manager; Joanna Mazur, Sales Assistant, jmazur@fto.ca.



Manufacturer of specialty multimode silica fibers and assemblies!

Fischer Connectors

#122

37/ 41 Rue Louise Weiss, PARIS, France, 75013
+33 1 55 78 25 78; fax +33 1 55 78 25 75
mail@fischerconnectors.fr; www.fischerconnectors.fr

Fischer Connectors looks for the optimum solution for an efficient and reliable connection. Our connectors have an excellent reputation, in sectors whose applications require customized development and faultless quality: Medical equipment, industrial instrumentation, controlling and measuring devices, audio-video, telecommunications, military applications. We are always prepared to invest as much time and effort as necessary to ensure you get the connector best suited to your needs. Contact: Guy Lacroix, Director.



New Fischer low profile rear-mounting connectors – YOUR SOLUTION TO COMPACT PRODUCT DESIGN

Flexible Optical BV

#514

Rontgenweg 1, DELFT, The Netherlands, 2624 BD
+31 15 2851547; fax +31 15 2851548
www.okotech.com

New Product: Low-cost piezoelectric deformable mirror with 109 actuators.

Flexible Optical B.V. (aka OKO Technologies) develops, manufactures and delivers adaptive optical systems for wavefront correction and generation in scientific, industrial and medical applications, based on MEMS and piezoelectric deformable mirrors. Contact: Gleb Vdovin, Chief Executive Officer, gleb@okotech.com.



Low-cost piezoelectric deformable mirror with 109 actuators.

FRAMOS GmbH

#106

Semiconductor, Dauthendeystr 2, Munich, Germany, 81377
49 89 710 6670; fax 49 89 710 66766
info@framos.de; www.framos.de

New Product: CCD/CMOS Sensors, CCD/CMOS Cameras, Lenses, Illumination, Software, Image Processing Solutions.

Framos Imaging Solutions has been active in the industrial image processing sector for more than 25 years. In our branches in Germany, England, France and Italy, we offer a comprehensive range of image processing components and solutions. Through our proximity to acclaimed partner companies (including Sony Imaging Sensors), we help our customers to continually be one step faster informed about the new technological developments and offer the best service, quality and conditions. Contact: Emmanuel Maridor, Sales Manager, e.maridor@framos.fr.



MegaPlus EC16000: 16MPixel Resolution; Full 35mm Image Sensor Size; Actively Cooled Camera.



Frank Optic Products GmbH

#105

Heidelberger Str 63-64, Berlin, Germany, 12435
+49 30 530249 0; fax +49 30 530249 21
info@fop-berlin.de; www.frank-optic-products.de

New Product: Autoclavable-capable Medical Fibres, High Power Laser Cables, Laser Windows, Ceramic Reflectors.

FRANK OPTIC PRODUCTS® makes the concentrated worldwide know-how in Photonics for customized solutions to problems available to you. Our many years of experience, our highly qualified interdisciplinary team of experts as well as our extensive and modern production and measuring technology, guarantee that we can implement all types of customers requirements, ranging from prototyping to large series. We are one of the leading specialists in Laser technology, Fibre optics and Special optics. Contact: Dieter Frank, President Chief Executive Officer, d.frank@fop-berlin.de; Dipl.-Phys. Heiko Jacobs, Senior Manager, h.jacobs@fop-berlin.de.

Photonics Europe
 Strasbourg 2008, France
 8-10 April 2008
Stand 328

ET Enterprises offer ultra-low temperature photomultipliers for operation at -200 °C

Our range of photomultipliers for ultra-low temperature applications includes diameters from 25mm to 200mm, hemispherical, convex, plano-concave and flat window options.

These photomultipliers are suitable for

- high energy physics studies
- liquid argon and xenon detectors
- Inorganic scintillators
- UV light detection
- Ultra low background

ET Enterprises Limited
 Bury Street
 Ruislip, Middlesex, UK
 tel: +44 (0)1895 630773
 fax: +44 (0)1895 631774
 info@electron-tubes.co.uk

Electron Tubes
 100 Forge Way, Unit F
 Rockaway, NJ 07866, USA
 tel: (973) 586 9594
 fax: (973) 586 9771
 sales@electron-tubes.com



Visit our website at
www.electrontubes.com



Fraunhofer Heinrich Hertz Institut

#321

Einsteinufer 37, Berlin, Germany, 10587
49 30 31002 0; fax 49 30 31002 551
info@hhi.fraunhofer.de; www.hhi.fraunhofer.de

New Product: Fibre based THz Systems at 1.5 μm .

Photonic Components from sensing to information technology - this is the range of applications developed at the HHI. LEDs, Lasers, THz devices, fast diodes and the integration of these devices make up the scope of components. There is also profound competence in DOEs and polymer devices. We develop according to customer specifications and fabricate in small volumes. Contact: Wolfgang Schlaak, Head Business Development, schlaak@hhi.fhg.de; Bernd Srororius, Project Manager, srororius@hhi.fhg.de.

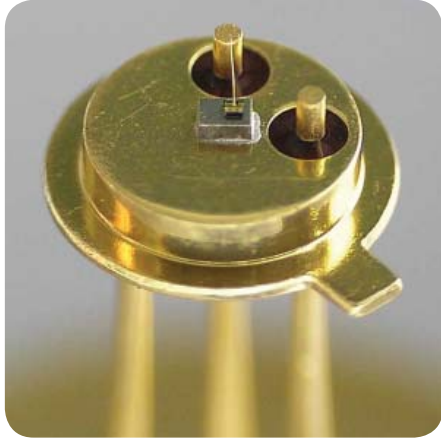

Customized Solutions for Industrial Applications.

Fujian CASTECH Crystals, Inc.

#501

No 155 Yangqiao West Rd, Fuzhou Fujian, China, 350002
86 591 371 0533; fax 86 591 371 1593
sales@castech.com; www.castech.com

CASTECH is a world famous manufacturer of crystals for lasers and their applications, with 18 years experience. It is devoted to the development, manufacturing and marketing of a wide range of NLO, laser, birefringent, E-O as well as optical crystals. New LBO coating is available, with high damage threshold, long life time and low reflectivity ($R < 0.05\%$ @ 1064nm, $R < 0.1\%$ @ 532nm), make your laser more efficient and stable. Contact: Sharon Lin.

Gorman-Rupp Industries

#413

180 Hines Ave, Bellville, OH, 44813
419/886-3001; fax 419/886-2338
www.gripumps.com

New Product: GRI's Brushless DC Magnetic-Drive Pumps line is ideal for laser and electronics cooling equipment.

Gorman-Rupp Industries is an OEM manufacturer of fluid handling pumps and pumping systems. Our goal is to meet your exact pumping needs, whether it is modifying a current product or designing a new pump according to your exact specifications. GRI's technical sales staff and engineering departments is structured to quickly evaluate your application and create a solution specific to your pumping needs. For more information, visit our booth at Photonics Europe or log onto to www.GRIpumps.com. Contact: Jan Skov, European Sales Manager, jan.skov@gripumps.dk; Michael Hill, Director of Sales and Marketing, mhill@gripumps.com.



GRI's Brushless DC Magnetic-Drive Pumps line is ideal for laser and electronics cooling equipment.

GWU-Lasertechnik GmbH

#501

Talstr 3, Erfstadt, Germany, 50374
49 2235 955220; fax 49 2235 75632
info@gwu-group.de; www.gwu-group.de

GWU-Lasertechnik specializes on OPOs and tunable laser systems including integrated systems with pump laser, OPO and frequency converter. Further products: Fiber lasers, DPSS lasers, Spectrelle-Echelle spectrographs, bulk and QPM crystals (laser and non-linear), optical components. Contact: Rainer Brünger.



VERTICAL BANNER SPONSOR

Hamamatsu

#231

19, Rue du Saule Trapu, Parc du Moulin de Massy, Massy Cedex, France, F-91882
33 1 69 53 7100; fax 33 1 69 53 7110
infos@hamamatsu.fr; www.hamamatsu.fr

New Product: MPPC Multi Pixel Photon Counter. A new type of Silicon ADP photon counter.

We develop and manufacture the most up to date light related sensors and instruments: Photomultipliers; Photodiodes; CMOS and CCD sensors; Infrared detectors; Microchannel plates and image Intensifiers; Mini spectrometers; Detectors and sources for X rays; Xenon - Xenon-Mercury and Deuterium lamps; Laser diodes; Equipments for semi-conductor and pharmaceutical industries; Microscope slides digitalization machines; Digital CCD board cameras and high grade digital cameras. Contact: Anne Llorens, Communication Coordinator, allorens@hamamatsu.fr.

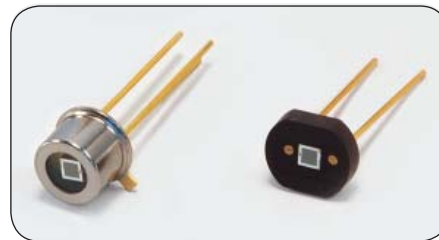

MPPC : Multi Pixel Photon Counter . A new type of Silicon APD photon counter.

HC Photonics Corp

#501

Science Based Industrial Park, 4F No 2 Technology Rd, Hsinchu, Taiwan, 300
886 3 666 2123; fax 886 3 666 2124
service@hcphotonics.com; www.hcphotonics.com

HC Photonics specializes in optical wavelength converters based on Periodically Poled Nonlinear Materials: PPMgO:CLN/SLT/SLN. With SHG/OPG/OPO/SFG/DFG configurations to cover 400 to 5500 range for full spectrum applications including RGB display, biophotonics, scientific and others. Contact: Karin Wu, Sales Manager, karin@hcphotonics.com.

Heptagon

#521

Moosstrasse 2, Zurich, Switzerland 8803
+41 44 497 30 25; fax +41 44 497 30 01
sales@heptagon.fi; www.heptagon.fi

Heptagon develops, designs and manufactures optics for a variety of applications, including mobile phones, communications, LED-based projectors, and general illumination systems. Heptagon's components are based on novel diffractive optics and micro-optics. Heptagon's micro optical components are produced by a propriety batch wafer-scale REEMO® UV-replication process. This enables low-cost in mass production and high robustness. Materials are available that can withstand a lead-free reflow process (temperatures up to 280°C), long-term storage and humidity and temperature shocks (in conformance with Telcordia/JEDEC regulations).

HOLOEYE Photonics AG

#309

SPIE Corporate Member

Albert-Einstein-Str 14, Berlin, Germany, 12489
49 30 6392 3660; fax 49 30 6392 3662
contactl@holoeye.de; www.holoeye.de

HOLOEYE Photonics AG is providing products and services in the fields of diffractive optics (DOE), spatial light modulation (SLM) and LCOS microdisplay components. HOLOEYE offers design and production services of diffractive micro-optical elements, standard Diffractive Optics, Spatial Light Modulators (SLM) which are based on high-resolution translucent or reflective microdisplays and a great variety of microdisplay types and products as OEM solution in higher quantities.



PLUTO: Compact Phase Only LCOS Spatial Light Modulator.

HORIBA Jobin Yvon SAS

#327

16-18 rue du Canal, Longjumeau cedex, France, 91165
+33 1 64 54 13 00; fax +33 1 69 09 07 21
info@jobinyvon.fr; www.jobinyvon.fr

HORIBA Jobin Yvon is one of the world's largest manufacturers of analytical and spectroscopic systems and components: Analytical and modular research spectrofluorometers for lifetime and steady-state; Raman spectrometers; X-ray fluorescence; Spectrographs, CCD & ICCD detectors, light sources and modular spectroscopic systems; Industrial and spectroscopic ellipsometers.



The XploRA concept brings Raman chemical imaging to your microscope.

id Quantique SA

#405

Chemin de la Marbrerie 3, Carouge/Geneva, Switzerland, CH-1277
41 22 301 83 71; fax 41 22 301 83 79
info@idquantique.com; www.idquantique.com

New Product: The id400 is a photon counter optimized for 1064nm with a detection probability higher than 30%.

World leader in single photon counting. The id100 family is a single-photon detection module based on a Si APD. It offers high detection efficiency over a wide spectral range, low dark count rate and best-in-class timing resolution of 40 ps. The id200 family is a single photon detection module based on InGaAs/InP APD. It features high detection efficiency up to 25%. The id400 is photon counting module optimized for 1064nm with a detection probability higher than 30%. Contact: Leonard Widmer, Vice President Sales, leonard.widmer@idquantique.com.



id400 Photon Counter optimized for the 1064nm wavelength.

Impex HighTech GmbH

#411

SPIE Corporate Member

Hovesaatstr 6, Rheine, Germany, 48432
49 5971 981650; fax 49 5971 981659
sales@impex-hightech.de; www.impex-hightech.de

New Product: 1064-Q laser with high energy >200µJ at 1kHz rep. rate and 2 ns pulse is new and >100µJ at 532nm.

Impex HighTech is manufacturer of lasers, custom optics and optical crystals. Core business is sapphire crystal growth and laser crystals. Since several years Impex HighTech also produces its own real monolithic, passively q-switched lasers (Nd:YAG / Cr4+:YAG) at 1064 nm and 532 nm with > 200 µJ at 1 kHz repetition rate and 2 ns pulsewidth. To complete the product range Impex offers also continuous wave (CW) lasers (longitudinal multimode or single frequency) at 1064 nm and 532 nm. Contact: Jens Meyer, Sales Engineer Laser Systems, meyer@impex-hightech.de; Helene Dyck, Managing Director, hdyck@impex-hightech.de.



355-Q Laser - nanosecond pulsed UV-Laser-System with µJ pulseenergy and kHz pulse repetition rate.

Innolume GmbH

#115

Konrad-Adenauer-Allee 11, Dortmund, Germany, 44263
49 231 4773 0200; fax 49 231 4773 0520
info@innolume.com; www.innolume.com

Institut d'Optique Graduate School #437

Campus Polytechnique RD 128, Palaiseau cedex, France, 91127
+33 1 6453 3100; fax +33 1 64 53 31 84
fc@institutoptique.fr; www.institutoptique.fr

New Product: Training courses in optics for non-specialists with the Rules of Thumb for Optics.

The Institut d'Optique Graduate School is a private higher education and research institution. Its Continuing Education Department proposes short training courses in optics from basics to advanced courses, specializations until optics and related domains. They are dedicated to all categories of employees: researchers, engineers, operators, technicians. It also meets specific needs for companies through dedicated courses, that can take place in the Institut d'Optique premises or in-house. Contact: Nathalie Cerre, Continuing Education Development and Marketing Manager, nathalie.cerre@institutoptique.fr.



Institut d'Optique Graduate School.

International Society for Stereology #529

Korytkova 2, Ljubljana, Slovenia, SI-1000
386 1 5437 300; fax 386 1 5437 301
www.wise-t.com/ias

New Product: Image Analysis and Stereology.

The International Society for Stereology (ISS), founded in 1961 and incorporated in 1963, includes members from the fields of mathematics, statistics, biology and materials science. ISS organizes courses and workshops on stereology and image analysis. The International Congress for Stereology and the European Congress for Stereology are organized in exchange every two years. <http://www.stereologysociety.org/>.



Image Analysis & Stereology is the official journal of the International Stereological Society.

iXfiber #126

Rue Paul Sabatier, Lannion, France, 22300
33 2 96 04 10 50; fax 33 2 96 04 10 60
info@ixfiber.com; www.ixfiber.com

New Product: Photodarkening Free Double Clad Fiber for High Power Fiber Laser application.

iXfiber is a French independent manufacturer of : Specialty Optical Fibers (Gyroscope PM Fiber, Er, Tm, Yb, Er/Yb Rare Earth Doped Fiber, Double Clad Fiber, HNA Fiber, Photosensitive Fiber, custom design...); Components based on Fiber Bragg Gratings technology (Mirrors for Fiber Laser, Gain Flattening Filter, Laser Diode Stabiliser, Sensor, custom design up to 2 micron)and Services. Contact: Patrice Crochet, Sales Director.

KERDRY #120

5 Rue Louis de Broglie, Lannion, France, F-22300
33 2 96 48 84 77; fax 33 2 96 48 84 78
contact@kerdry.com; www.kerdry.com

The company has extensive experience in design and manufacturing of high performance optical coatings and specializes in metallization. Precision Metal coatings: evaporation and sputtering (Au, Ag, Al, Ti, Cr, Ni, Cu...); Laser resistant optical coatings based on your own spectral data: AR, Mirror coatings or specific optical filters from 350 to 2000 nm; Fiber Optics: Specific expertise in optical coating on fiber end combined with metallization for fibers used in harsh environment. Contact: Keromnes Jean-Claude, Chief Executive Officer.

Kimoga Material Technology Co., Ltd. #520

SPIE Corporate Member

512 Chung-Ho, Pei-To, Taipei, Taiwan, 11252
886 2 28918690; fax 886 2 28935226
material2@kimoga.com.tw; www.kimoga.com.tw

New Product: Aspherical, Spherical lens, Prism, Quartz, Filter, UV IR materials, Sapphire, Grating, SmCo, YVO₄, LiNbO₃.

Kimoga manufacture lens to support the optical devices with competitive prices. We are specialized in but not limited to optical parts, i.e. prism mirror, aspheric surface lens, spherical glass, quartz Rod and more. Incorporate with Oversea Optical Science technology, we can provide service made on demand for any parameters. You name it and we can make it. We got excellent customer feedbacks. For a list of materials and products we make, please visit our website. Contact: Michael Shei, General Manager; Alicia Chen, Sales Manager, sales@kimoga.com.tw.



Silica Aspherical, Silica Cylindrical lens, Silica Rod...



COFFEE BREAK SPONSOR

KLASTECH

#420

Konrad-Adenauer-Allee 11, Dortmund, Germany, 44263
49 231 47730 646; fax 49 231 47730 620
info@klastech.de; www.klastech.de

New Product: Single frequency DPSSL, 532 nm / 2 W, single frequency DPSSL, 347 nm / 100 mW.

KLASTECH-Karpushko Laser Technologies GmbH develops and manufactures single frequency TEM₀₀ DPSSL-lasers. The products are based on proprietary DENICAF technology (Double ENhanced Intra-Cavity Frequency Conversion) that inherently features stable single longitudinal mode and low noise operation. KLASTECH offers standard products and customized laser development. Product range includes DPSSL at 1064 nm up to 4 W, 532 nm up to 2 W, 488 nm up to 50 mW, 442 nm up to 20 mW and 347 nm up to 100 mW. Contact: Ralf Rohmert, Chief Financial Officer, r.rohmert@klastech.de.

Laser Components GmbH

#220

Werner von Siemens Str 15, Olching, Germany, 82140
49 8142 28640; fax 49 8142 286411
info@lasercomponent.com; www.lasercomponents.com

New Product: Avalanche Photodiodes with Integrated Filter and Large Area APDs, multi-junction PLDs @ 905 nm.

The LASER COMPONENTS Group specializes in the production and distribution of high-tech components for the optoelectronic and laser industries. Main products are avalanche photodiodes and high power pulsed laser diodes. We also make hard dielectric coatings for laser optics, offering the complete spectral range from 193 nm to 5 µm. Our spectroscopic lasers and systems cover the whole range from 3 - 25 µm and include QCLs. High quality laser diode modules complete our product range. Contact: Sven Schreiber, Export Manager, s.schreiber@lasercomponents.com.



New Avalanche Photodiodes with Integrated Filter at 905 nm.

Laser Focus World

#414

SPIE Corporate Member

98 Spit Brook Rd, Nashua, NH, 03062
603/891-0123
www.laserfocusworld.com

Laser Focus World is a monthly magazine for engineers, researchers, scientists and technical professionals providing comprehensive global coverage of optoelectronic technologies, applications and markets. The magazine reports on and analyzes the latest developments and significant trends in both technology and business in the worldwide optoelectronics and photonics industry. Contact: Katrina Frazer, Group Exhibits Director, katrinaf@pennwell.com; Sharon MacLeod, sharonm@pennwell.com.

Laser Zentrum Hannover e.V. (LZH)

#505

Hollerithallee 8, Hannover, Germany, 30419
49 511 2788 0; fax 49 511 2788 100
info@lzh.de; www.laser-zentrum-hannover.de

The Laser Zentrum Hannover e.V. (LZH) carries out customer-oriented research, development and consulting in all fields of laser technology. Interdisciplinary teamwork and close cooperation with industry has helped the LZH achieve a leading position among the laser centers in Germany and abroad. The main fields of work for the LZH are customer-specific problem solving of practical applications, technical, scientific and economic consulting and industry-oriented training in laser technology.

LEONI Fiber Optics GmbH

#406

Muehldamm 6, Neuhaus-Schierschmitz, Germany, 96524
49 36764 81100; fax 49 36764 81110
fiber-optics@leoni.com; www.leoni-fiber-optics.com

New Product: Light guides for medical and industrial laser applications and light guiding high bride cables.

LEONI Fiber Optics is your specialist for fiber optics. We offer you a unique range of high-quality fiber optics beginning with the fiber preform, the drawn fibers, the cables and assembly as well as the components all the way to planning, installation and maintenance of complete networks. Contact: Otto Bernauer, Managing Director, otto.bernauer@leoni.com; Frank Gumm, frank.gumm@leoni.com.

Leukos

#123

ESTER technopole, BP 6928, Limoges cedex, France, 87069
33 5 55 35 81 27; fax 33 5 55 35 81 34
contact@leukos-systems.com; www.leukos-systems.com

LINOS Photonics France

#307

90 Avenue de Lanessan, Champagne Au Mont d'Or, France, F-69410
33 4 72 52 04 23; fax 33 4 72 53 92 96
info-fr@linos.com; www.linos.fr

New Product: Get your light where you need it: Laser coupler, fiber, collimator.

As a combination of SPINDLER & HOYER, GSÄNGER and RODENSTOCK Präzisionsoptik, LINOS is a manufacturer of sophisticated optical components and systems. LINOS, since 2006 a member of the QIOPTIQ group, is a reliable partner for customized solutions: Analysis, development, prototyping and serial production. In addition, LINOS supplies more than 4000 different standard components (catalog) for high-end solutions in industry and public research institutions.



Fiber components are now available with Linos quality.

Lovalite

#121

18 rue Alain Savary, Besançon, France, 25000
+33 38153626; fax +33 381255351
sales@lovalite.com; www.lovalite.com

New Product: A new generation of micro optical components.

Lovalite uses a proprietary process that combines photo-chemistry and advanced optics to produce sub micrometer optical elements especially designed to bring you light coupling solutions. Polarization maintaining technology for high efficiency coupling in modern integrated optics. Contact: Brahim Dahmani, Sales, Dahamani@Lovalite.com.

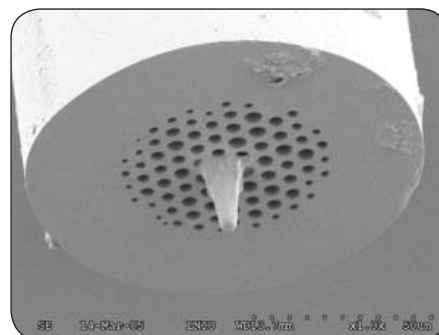

Product for near-field optical microscopy SNOM and for photonic coupling.

Exhibition Directory

Lumera Laser GmbH

Opelstr 10, Kaiserslautern, Germany, 67661
49 6301 703 180; fax 49 6301 703 189
info@lumera-laser.de; www.lumera-laser.de

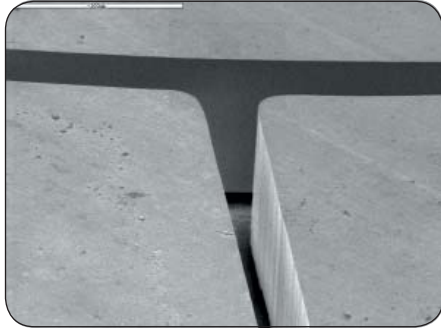

High quality micromachining with picosecond lasers. Our picture shows a 30µm groove in a metal foil.

Lumerical Solutions, Inc.

789 W Pender St Ste 660, Vancouver, BC, Canada, V6C 1H2
604/733-9006; fax 604/733-3188
sales@lumerical.com; www.lumerical.com

M.C.S.E.

38 rue de la Station, Franconville, France, F-95130
33 1 3415 2822; fax 33 1 34 15 28 86
mcse95@orange.fr; www.mcse.fr

Mad City Labs, Inc.

SPIE Corporate Member

2524 Todd Drive, Madison, WI, 53713
608/298-0855; fax 608/298-9525
sales@madcitylabs.com; www.madcitylabs.com

Materials Today

The Blvd, Langford Ln, Oxford, United Kingdom, OX5 1GB
44 1865 843000; fax 44 1865 843971
materialstoday@elsevier.com; www.materialstoday.com

Materials Today is the international review magazine for all researchers with an interest in materials science and technology. Available for free to researchers, it offers the best coverage of fast-moving and emerging topics in advanced materials. Peer-refereed review articles assess the latest findings and examine the future challenges for research. Our news covers significant advances across the whole of materials research. Free subscription, go to <http://www.materialstoday.com/register.html>. Contact: Helena Stewart, Senior Marketing Manager.



Materials Today - Free magazine qualifying subscription available at <http://www.materialstoday.com/register.html>

#310

Menlo Systems GmbH

Am Klopferspitz 19, Martinsried, Germany, 82152
49 89 189166 0; fax 49 89 189166 111
sales@menlosystems.com; www.menlosystems.com

Menlo Systems is a leading developer and global supplier of instrumentation for high-precision metrology. Known for its Nobel Prize winning optical frequency comb technology, the Munich-based company supplies ultrafast lasers, femtosecond phase stabilization units and a broad spectrum of high-sensitivity ultrafast photodetectors. Contact: Ida Kozma, Head of Sales and Marketing.



Dual femtosecond fiber laser ASOPS system for fast optical sampling.

Messe Stuttgart

Am Kochenhof 16, Stuttgart, Germany, 70192
49 711 2589 0; fax 49 711 2589 440
info@messe-stuttgart.de; www.messe-stuttgart.de

New Product: LASYS-systems for laser material processing; MINAT-micro+nano technologies; VISION-machine vision.

Organizer of highly-qualified and International technical trade fairs, www.messe-stuttgart.de. Contact: Silvia Blumenschein, International Business Development, silvia.blumenschein@messe-stuttgart.de; Ulrike Mayer, Representative of Messe Stuttgart in France, umayer@francoallemand.com.



PASTRIES SPONSOR, ATTENDEE PENS SPONSOR

MICOS GmbH

Freiburger Str 30, Eschbach, Germany, 79427
49 7634 5057 230; fax 49 7634 5057 393
sales@micos-online.com; www.micos.ws

New Product: MICOS is offering new linear and rotary stages with new controllers and piezo components.

MICOS is offering a wide range of positioning systems and optical benches. Linear, rotary and multiaxes stages for standard applications as well as high performance systems can be purchased and custom designed. MICOS is specialized in hexapodic systems especially for telecommunication and optoelectronic. We supply many products to the electronic industry, semiconductor and telecommunication technologies and provide comprehensive customer support, systems integration and after-sale service. Contact: Wolfgang Meienburg, Manager Sales; Maucher, Sales.

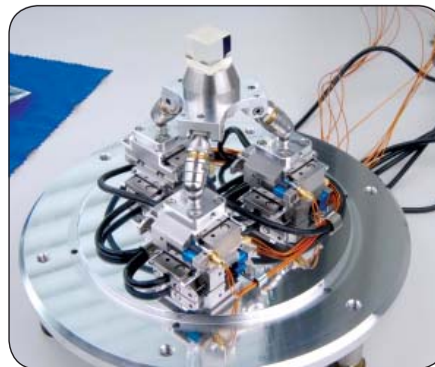

Piezo based system for nanopositioning in vacuum.

#517

#121

#128

#214

#435

#524

#511



CONFERENCE BAGS SPONSOR

Nature Publishing Group

#208

The Macmillan Bldg, 4 Crinan St, London, United Kingdom, N1 9XW
44 20 7833 4000; fax 44 207 843 4998
www.nature.com

Nature Publishing Group brings leading scientific and medical research to your desk top. The NPG portfolio combines the continued excellence of Nature and its associated research and review journals, over 42 leading academic and society journals and 8 Nature Clinical Practice journals. Visit Stand no: 208 for free sample copies including Nature Materials, Nature Nanotechnology, Nature Photonics and Nature Physics. www.nature.com. Contact: Nature Publishing Group.

NEMO (Network of Excellence on Micro-Optics)

#217

Pleinlaan2, Brussel, Belgium, 1050
0032 2629 3568; fax 0032 2629 3450
info@micro-optics.org; www.micro-optics.org

New Focus, Inc.

#317

SPIE Corporate Member

A division of Bookham, 2584 Junction Ave, San Jose, CA, 95134-1902
408/919-1500; fax 408/919-1501
contact@newfocus.com; www.newfocus.com

New Focus, a division of Bookham is a leading supplier of Simply Better Photonics for advanced research, semiconductor equipment and industrial applications. Products include single-wavelength and tunable lasers, detectors, modulators, motion control actuators and solutions, optomechanics, vacuum and ultraclean solutions, optics, breadboards and integrated precision OEM solutions.

Newport Spectra-Physics

#205

1 Rue Jules Guesde - BP189, Evry Cedex, France, F-91006
33 1 60 91 68 15; fax 33 1 60 91 68 69
france@newport-fr.com; www.newport.com

New Product: Newport 842-PE Handheld Power/Energy Meter.

Newport Spectra-Physics is a leading global supplier of solution to make, manage and measure light to the semiconductor, communications, electronics, research and life and health sciences markets. Contact: Dalila Ait Amir, Sales Engineer, dalila.aitamir@newport.com; Claude Minard, Sales Engineer, claude.minard@newport.com.



Newport 842-PE Handheld Power/Energy Meter.

NEYCO

#212

84 Rue de Levis, Paris, France, 75017
+33 14053 0753; fax +33 16053 0752
contact@neyco.fr; www.neyco.fr

New Product: Materials for thin films and vacuum accessories.

NEYCO offers a wide range dedicated to vacuum and thin films applications: evaporation materials, sputtering targets, quartz for thickness measurement, vacuum components, vacuum pump fluids and greases. Contact: Isabelle Richardt.



Vacuum deposition EB liners from NEYCO.

NIL Technology

#125

Bldg 347, Oerstedts Plads, Kongens Lyngby, Denmark, 2800
45 3111 1797; fax 45 7014 1916
contact@nilt.com; www.nilt.com

NIL Technology manufactures and sells stamps for nanoimprint lithography (NIL), provides imprint service, production by NIL, consultancy and enters into joint development of novel applications benefiting from nano-scale structures. Our stamps are engineered to order from customer defined specifications regarding patterns materials and formats. Contact: Lars Hansen, Director of Sales, lars.hansen@nilt.com; Theodor Nielsen, Chief Executive Officer, theodor.nielsen@nilt.com, www.nilt.com.; Brian Bilenberg, Chief Technology Officer, bb@nilt.com.

NP Photonics

#501

9030 S Rita Rd, Tucson, AZ, 85747
520/799-7496; fax 520/799-7403
info@np Photonics.com; www.npphotonics.com

NP Photonics, a leading fiber laser company, produces and delivers a new class of advanced optical light sources for sensing, medical and R&D markets. The company has developed a broad family of products including Narrow-Line width/low phase noise Fiber Lasers, ASE Sources and High Power Single Frequency Light Sources. Contact: Christine Spiegelberg, spiegelberg@np Photonics.com.

Nufern

#428

SPIE Corporate Member

7 Airport Park Rd, East Granby, CT, 06026
860/408-5000; fax 860/408-5080
info@nufern.com; www.nufern.com

Nufern® is a leading U.S. manufacturer of specialty optical fibers, fiber lasers and amplifiers serving diverse markets. Current products include over 300 standard fibers and range from sub-assemblies to complete turn-key fiber lasers and amplifiers. From its headquarters in East Granby, Conn., USA, Nufern's integrated fiber and fiber laser teams also provide rapid and cost-effective OEM fiber laser design, assembly and contract manufacturing services. Contact: Kristoff Felisik, Director of Sales-Europe, kfeliksik@nufern.com; Andrzej Szkotnicki, Sales Representative, aszkotnicki@nufern.com.

NuSil Technology

#525

2740 route des Crêtes, Sophia Antipolis, CA, France, 06906
+33.(0)4.92.96.93.31; fax +33.(0)4.92.96.06.37
nusil.sophia@nusil.com; www.nusil.com

Exhibition Directory

Ocean Optics

#110

Geograaf 24, Duiven, The Netherlands, NL-6921 EW
31 26 319 0500; fax 31 26 319 0505
sales@oceanoptics.eu; www.oceanoptics.com

New Product: Jaz, the UV-VIS-NIR spectrometer with onboard microprocessor and display, modular, battery powered.

Smart, Innovative, Flexible, Solvers: Ocean Optics is the leading supplier of solutions for optical sensing. Our extensive line of products includes Spectrometers, Optical Sensors, Sampling Accessories, Light Sources, Fibers and Probes. Recognized as the inventor of miniature fiber optic spectroscopy, Ocean Optics has sold more than 100,000 spectrometers worldwide since 1989. New is the revolutionary Jaz (with onboard microprocessor and display) and the Maya (with back-thinned detectors). Contact: Henri Tellegen, Sales Engineer; Marjolein Ladestijn, Customer Service.



The new Jaz (onboard processor & display) and Maya (with back-thinned detectors).

OLLA Project

#429

Philipsstrasse 8 (PVI.538), Aachen, Germany, 52068
+49 241 539 3161; fax +49 241 539 2399
visser@olla-project.org; www.olla-project.org

Omega Optical, Inc.

#107

Delta Campus, Omega Drive, Brattleboro, VT, 05301
+1-802-251-7300; fax +1-802-254-3937
sales@omegafilters.com; www.omegafilters.com

Omega Optical offers standard and custom optical filters. The extensive range of products includes bandpass, longpass/shortpass, rejection bands, dichroic beamsplitters/mirrors, neutral density, laser line, analytical, astronomy and fluorescence filters. Omega Optical adds in Dual Magnetron Reactive Sputtering coating capability to satisfy requirements for high-performance surface coatings. Contact: Ruth Gorham-Houle, Vice President of Business Development, rgorham@omegafilters.com.

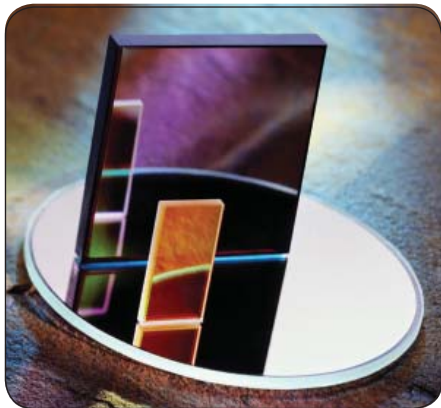

Omega Optical, Inc. - Precision Optical Filters.

OpTIC

#333

Ffordd William Morgan, St Asaph Business Park, St Asaph
Denbighshire, United Kingdom, LL17 0JD
44 1745 586256; fax 44 1745 586259
info@optictchnim.com; www.optictchnim.com

OpTo-electronics Technology and Incubation Centre specializes in display and digital holography, high power custom designed solid state lasers from 1.3 μm to uv (with systems available for RGB holographic printing systems), large area precision spherical and aspherical optics, polymers for opto-electronic applications, optical design and packaging, research in thin film optical coatings. Additionally, OpTIC offers contract development for companies engaged in opto-electronic technology. Contact: Ian Maxwell, Marketing Manager, ian.maxwell@optictchnim.com; Dave Rimmer, Managing Director, dave.rimmer@optictchnim.com.



Custom designed and built solid state lasers including RGB systems.

Optics & Laser Europe

#312

Dirac House, Temple Back, Bristol, United Kingdom, BS1 6BE
44 1179 297481; fax 44 1179 301178
info@iop.org; www.optics.org

IOP Publishing, a not for profit company wholly owned by the Institute of Physics, is one of the largest and most dynamic publishers of physics information in the world. Our publishing activity, which dates back to 1874, includes a wide range of journals, magazines and community websites. We partner more than a dozen international organizations and have a global network of offices located in Bristol, Philadelphia, Washington DC, Munich, St Petersburg, Moscow, Beijing and Tokyo. Contact: Cadi Jones, Advertising Manager, cadi.jones@iop.org; Claire Bedrock, Publisher, claire.bedrock@iop.org.



Optics & Laser Europe magazine provides independent news coverage of the global photonics industry.

Optics Pages

#527

Old Village Hall, The Street, Effingham Surrey, United Kingdom,
KT24 5JS
+44 1372 750522; fax +44 1372 750666
info@opticspages.com; www.opticspages.com

Optics Pages is a new on-line resource for sourcing photonics products. Visit to see our all new website. Companies: Visit to register your company for FREE on the Optics Pages. Subscribe for a free 'Information Page', offer exclusive for Photonics Europe Exhibitors. Everyone else: Visit to register your name to learn more and browse this new photonics resource. Contact: Laurence Devereux.

OptiGrate

#510

3267 Progress Dr, Orlando, FL, 32826
407/381-4115; fax 407/384-5995
sales@optigrate.com; www.optigrate.com

New Product: Longitudinal and Transverse Chirped Bragg Gratings in PTR glass for CPA and SBC applications.

OptiGrate manufactures volume Bragg gratings (VBGs) in PTR glass for mode selection in lasers, spectral beam combining, optical communication, etc. VBGs for stabilization of semiconductor, solid state and fiber lasers are available for wavelengths from 350 to 2700 nm. Output couplers and high reflective mirrors with spectral bandwidth from 0.03 to 1 nm are manufactured for all laser types. OptiGrate is a pioneer in implementation of VBGs for revolutionary technology of laser projection displays. Contact: Vadim Smirnov, Director of Holography and Diffractive Optics, vsmirnov@optigrate.com; Igor Ciapurin, Project Manager, iciapurin@optigrate.com.

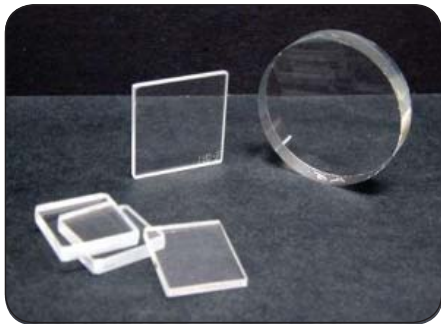

Volume Bragg gratings (VBG's) in a photo-thermo-refractive (PTR) glass.

Optima Research

#131

8 Riverside Business Park, Stoney Common Rd, Stansted, United Kingdom, CM24 8PL
44 1279 810911; fax 44 1279 810912
info@optima-research.com; www.optima-research.com

Optima Research is the European distributor for the ZEMAX Optical Design Software Package. As ZEMAX specialists we also provide technical support and training on the software. Contact: Michael Johnson, Optical Engineer, michael.johnson@optima-research.com.

OptoIndex

#531

Papier Muehlenweg 74, Ratingen, Germany, 40882
49 2102 1678 0; fax 49 2102 1678 28
info@opto-index.de; www.opto-index.de

New Product: OptoIndex for Photonics 2008.

The proliferation of Photonics in recent years creates the imperative need for an index. This work of Reference - OptoIndex for Photonics - offers a yearly updated comprehensive data source for companies and products in this sector. Who has the best solution to my problem? Where can I find a cost-effective shortcut? This catalogue and website www.opto-index.de/ot will help you to find answers. Contact: Julia Eckmann, Product Manager, julia@opto-index.de.

Opton Laser International

#130

Parc Club Orsay Université, 99 Rue Jean Rostand, Orsay Cedex, France, F-91893
33 1 69 41 04 05; fax 33 1 69 41 32 90
ventes@optonlaser.com; www.optonlaser.com

New Product: New high power bars, up to 300W qcw (up to 300µs, DC 10%) diode lasers at 808nm, passive cooling.

Opton Laser International is a supplier in photonics on the European market. The company offers a range of high quality products. We are actively presents on the following markets: Scientific, Industrial, Biophotonics, Military, Aerospace, Telecommunications, Environment. Opton Laser is based in Orsay, near Paris, the heart of the most important scientific community in Europe. We have an international reputation as an exigent and professional partner. Contact: Laurence Duchard, laurence.duchard@optonlaser.com.



QCW diode lasers with pulse power of 300W.

Optronis GmbH

#216

Honsellstr 8, Kehl, Germany, 77694
49 7851 91260; fax 49 7851 91260 10
info@optronis.com; www.optronis.com

Optronis develops and distributes cameras for scientific and industrial applications. Streak Cameras, Fast Video Cameras and Image Intensified Cameras of Optronis are being used to capture fast optical events and faint light signals. Contact: Patrick Summ, summ@optronis.com.



Very light sensitive high speed video camera from Optronis.

Exhibition Directory

OXXIUS

#304

4 Rue de Broglie, Lannion, France, F-22300
33 2 96 48 70 28; fax 33 2 96 48 21 90
info@oxxius.com; www.oxxius.com

OXXIUS manufactures ultra compact, extremely stable Diode Pumped Solid-State and Diode Laser modules in the visible and ultraviolet wavelength range (7 to 300mW at 561, 532, 473, 445, 405 and 375nm). Patented AMR Technology assures stable, noise-free single frequency operation, enabling superior performance in Biomedical, Analytical, Inspection and Interferometric applications. Contact: Bruno Lefevre, Sales Director, blefevre@oxxius.com.



Oxxius offers compact DPSS Lasers in 561, 532 and 473nm.

Phoenix BV

#315

Hengelosestr 705, Enschede, Netherlands, 7521
31 53 483 6460; fax 31 53 433 7415
info@phoenixbv.com; www.phoenixbv.com



LANYARDS SPONSOR

Photon Design

SPIE Corporate Member

34 Leopold St, Oxford, United Kingdom, OX4 1TW
44 1865 324990; fax 44 1865 324 991
info@photond.com; www.photond.com

#204

New Product: PICWave - photonic IC circuit simulator for modeling both passive and active components.

Photon Design, founded 1992, provides a wide range of photonics software for integrated and fibre-based component design. Products include FIMMPROP-our revolutionary bi-directional optical propagation tool, FIMMWAVE - our famous mode solver, PICWave - our new active/passive photonic-IC circuit simulator, CrystalWave-photonic crystal simulator, OmniSim-general purpose 3D FDTD simulator. Contact: Dominic Gallagher, Chief Executive Officer; Christie Wang, pdadmin@photond.com.

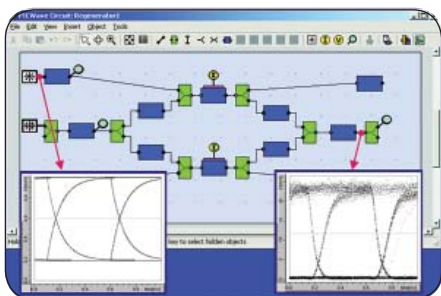

PICWave - a photonic IC simulator, here modeling an optical regenerator.

Photonex 2008

#527

Old Village Hall, The Street, Effingham Surrey, United Kingdom, KT24 5JS
44 1372 750555; fax 44 1372 450666
info@photonex.org; www.photonex.org

Photonex08 is The UK's Premier Photonics Event. It is the most important opportunity in 2008 to meet United Kingdom buyers. Its diverse subject matter makes it unique in the United Kingdom. PHOTONEX is where serious buyers visit to compare, contrast and source products and services and solve problems. Exhibiting at is vital if you wish to establish distribution channels and business partners. This years dates: 15 and 16 October at Stoneleigh Exhibition Halls, Nr Coventry. Contact: Laurence Devereux.

Photonic Cleaning Technologies

#421

SPIE Corporate Member

1895 Short Ln Bldg 1, Platteville, WI, 53818
608/467-5396; fax 608/467-5397
sales@photonicleaning.com; www.photonicleaning.com

New Product: Red Spray First Contact-Safe, easy application. Prevents recontamination, surfaces always ready!

Photonic Cleaning Technologies manufactures First Contact™ Polymer products, the next generation of optics cleaning and protection materials. The only 'cleaning and protection system' in a bottle, apply First Contact™ by spraying, dipping or manually. Easy to use, environmentally friendly, safe and effective. We provide complete manual spray systems and brush application kits. Available worldwide from authorized distributors, see the Independent Distributors page on www.PhotonicCleaning.com. Contact: Philip Jackson, jacksonp@photonicleaning.com.



Spray Red First Contact: Cleans and Protects Electro-optics.

Photonics 4 Life - Network of Excellence

#427

C/o Institute of Photonic Technology, Jena, Germany, 07745
+49 3641 206 301; fax +49 3641 206 399
juergen.popp@uni-jena.de;

Photonics Spectra - Laurin Publishing #100

Berkshire Common, 2 South St, Pittsfield, MA, 01201-6109
+413/499-0514; fax 413/442-3180
photonics@laurin.com; www.photonics.com

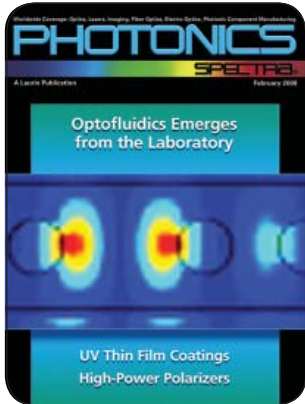

The leading photonics magazine serving industries that use photonic technology.

Photonik Zentrum Hessen in Wetzlar AG #222

SPIE Corporate Member

Charlotte-Bamberg-Strasse 6, Wetzlar, Germany, 35578
+49-(0) 64 41 - 21 04 3-0; fax +49-(0) 64 41 - 21 04 3-14
info@pzh-wetzlar.de; www.pzh-wetzlar.de

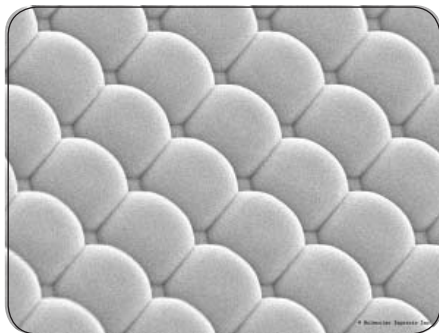

SEM micrograph of the surface of a close-packed micro lens array.

Physik Instrumente (PI) GmbH & Co. #308

Auf der Römerstrasse 1, Karlsruhe, Germany, 76228
49 721 4846 0; fax 49 721 4846 299
info@pi.ws; www.pi.ws

PI is a world leading OEM and Research supplier of piezoelectric NanoPositioning and motorized MicroPositioning systems, including drive technology, mechanical setup, motion controllers and software. Applications in the following industries: Semiconductors, Medical Technology, Optics, Biotechnology, Photonics, Fiber Optics, Lasers, Aerospace, Metrology, Precision Machine Tooling, Astronomy. Products: Piezoelectric and Motorized Actuators, Parallel-Kinematic Positioning Systems, Hexapod 6D-MicroRobots, Capacitive Position Sensors, PZT Ceramics, Piezo Motors and Linear Drives, Active Steering Mirrors, Digital and Analog Motion Controllers, Fiber Aligners.

Point Source #113

SPIE Corporate Member

Ensign Way, Mitchell Point, Hamble Southampton, United Kingdom, SO31 4RF
44 2380 744 500; fax 44 2380 744 501
sales@point-source.com; www.point-source.com

Point Source - laser solutions for precision instrumentation Point Source designs and manufactures high performance fiber optic laser delivery systems and lasers for commercial applications in biotechnology and semiconductor manufacturing. At Photonics Europe Point Source will show a selection of its latest laser systems including the brand new iFLEX-Mustang, a fiber-coupled solid-state laser with on-board acousto-optic modulation. The Point Source showcase will also include the reliable and robust fiber coupled iFLEX-2000 and the compact laser diode system iFLEX-Q3.



The iFLEX Mustang fiber-coupled solid-state Laser.

Quantel #305

BP 23 , 2 Bis Avenue du Pacifique, LES ULIS cedex, France, F-91941
33 1 6929 1700; fax 33 1 6929 1729
quantel@quantel.fr; www.quantel-laser.com

New Product: A new laser picosecond. New technology, no more dye, it delivers 100mJ in 30 ps on 10Hz @1064nm.

Quantel is a leader in pulsed solid state lasers. The company is based in France near Paris. Quantel offer you a wide range of modular nanoseconds lasers and also a picoseconds laser and a dye laser. Quantel propose non standard laser thanks to our R&D department. Our lasers are mainly use in the scientific research for spectroscopy (CARS, LIBS, LIF), ablation, PIV, PLD. Contact: Melanie Leseignoux, Sales Area Manager, melanie.leseignoux@quantel.fr.

Raicol Crystals Ltd. #206

15 Giron St Industrial Zone, Yehud, Israel, 56217
972 3 936 7412; fax 972 3 906 8969
info@raicol.com; www.raicol.com

New Product: Periodically Poled SLT Crystal, (PPSLT), SLT crystal, RTP Q-SW.

Raicol manufactures nonlinear optical elements, including KTP, HGTR KTP, RTP, PPKTP and PPSLT. Raicol's newest products are the RTP electrooptic Q-switch operating for high-power high-repetition rate applications (up to 1.2 Mhz repetition rate), the monolithic KTP OPO and Stoichiometric Lithium Tantalate (SLT) crystals. Raicol also supplies Cr:YAG, BBO and LBO elements. Contact: Moshe Shapira, Vice President of Marketing and Sales, moshe@raicol.com; Alex Skliar, Chief Technology Officer, alexs@raicol.com.

Exhibition Directory

Rhenaphotonics Alsace #533, 535, 537, 539

Parc d'Innovation - ENSPS, Boulevard Sebastien Brant, BP 10412, France, F-67412
+33 3 90 24 46 38; fax +33 3 90 24 46 50

Since 2003, Rhenaphotonics Alsace has brought together the academic world, centres of excellence and businesses with an interest in optics and photonics in Alsace. As a facilitator of contacts between research and business partners, Rhenaphotonics Alsace boosts regional economic development by promoting cooperation between research laboratories and businesses interested in benefiting from this technological development. Contact: Paul Smigielski, President, smigielski@wanadoo.fr; Veronique Parasote, Project Manager, vparasote@rhenaphotonics.fr.

Royal Society of Chemistry #541

Thomas Graham House Science Park, Milton Rd, Cambridge, United Kingdom, CB4 0WF
44 1223 420066; fax 44 1223 421006
materials@rsc.org; www.rsc.org

The Royal Society of Chemistry (RSC) is the largest organization in Europe for advancing the chemical sciences, supported by 45,000 members worldwide and an internationally acclaimed publishing business. Visit our display to find out about the latest in photonics research in Journal of Materials Chemistry and other high quality, high impact journals from the RSC. Contact: Carol Stainer, Managing Editor, Journal of Materials Chemistry.

RSoft Design Group #320

SPIE Corporate Member

400 Executive Blvd Ste 100, Ossining, NY, 10562
914/923-2164; fax 914/923-2169
info@rsoftdesign.com; www.rsoftdesign.com

New Product: ModePROP 1.0, an Eigenmode Expansion Propagation Tool for Photonic Design and Simulation.

RSoft Design Group is the leader in photonics design software and serves several industries including optical communication, optoelectronics and semiconductor manufacturing. Within optical communications, RSoft is the only company to provide a full range of design, optimization and planning tools. RSoft also provides award-winning design tools for optoelectronics components and subsystems. Contact: Carl Klinges, carl@rsoftdesign.com; LuAnn Scarmozzino.

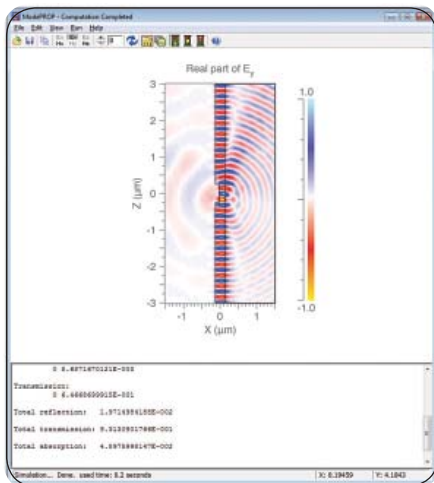

Simulation results that show the field scattered by an air groove.

RSP Technology BV #424

Metaalpark 2, Delfzijl, The Netherlands, 9936 BV
31 596 632 300; fax 31 596 632 678
info@rsp-technology.com; www.rsp-technology.com

New Product: RSP Aluminium reduces surface roughness for optical components under 2 nm for mirrors and moulds.

RSP Technology produces aluminium alloys for optical applications, like mirrors, moulds, housings, mounting and Gimbal-systems, with advantages for surface roughness, shape stability, strength and low thermal expansion. The meltspinning technology enables RSP to cool down materials at a speed of 10,000,000 ° C per second, "freezing" the liquid alloy, with superior specifications and ultra-fine microstructure. RSA Aluminium has a surface roughness less than 2 nanometer. Contact: Roger Senden, Sales Director, rsenden@rsp-technology.com.

Santec Europe Ltd. #409

Magdalen Ctr, Robert Robinson Ave, Oxford, United Kingdom, OX4 4GA
44 1865 784960; fax 44 1865 784961
info@santec.co.uk; www.santec.com

New Product: Tunable Lasers for Telecoms and Scanning Laser for Optical Coherence Tomography (OCT).

Established manufacturer of tunable lasers and test instruments for fibre optics. We supply the telecoms, fiber optic and gas sensing and material characterization industries. We are also the leading manufacturer of Scanning Lasers for Optical Coherence Tomography (OCT). We welcome enquiries for custom-made laser products for new applications. Contact: David Heard, Managing Director.

Scientec #412

ZA de Courtaboeuf, 17, avenue des Andes, Bâtiment le Cèdre, Les Ulis, France, 91952
+33(0)1 64 53 27 00; fax +33(0)1 64 53 27 01
info@scientec.fr; www.scientec.fr

New Product: Konica Minolta, TechnoTeam, Optronics Laboratories, Lyncée Tec, Filmetrics, n-Point.

ScienTec offers a large range of analysis instruments for Surface analysis, STM, AFM, SNOM, RAMAN, CONFOCAL, roughness measurement, interferometric optical microscopy and real time (Sarfus Technology and Holography) thickness measurement, mechanical profilometry, Nanoindentation. We are able to study and develop your projects made-to-measure or as a supplement to our products range. ScienTec Support Department advises you all the information you need for an optimum use of our equipments. Contact: Didier Pellerin, General Manager, d.pellerin@scientec.fr; Jean-Luc Rondeau, Department Manager, jl.rondeau@scientec.fr.

SEDI Fibres Optiques

#313

ZA St Guenault, 6 Rue Jean Mermoz, Courcouronnes, France, F-91080
33 1 69 36 64 00; fax 33 1 69 36 64 19
info@sedi-fibres.com; www.sedi-fibres.com

New Product: The "4Power" connector for very high power laser delivery system used in industrial or medical field

Serving the special applications fiber optic market for more than 20 years SEDI Fibres Optiques offers a unique range of optical fibers and manufacture components (connectors, couplers, WDMs, collimators, filters), as well as custom designed assemblies for applications including high temperature, high pressure, biocompatibility, radiation resistance, vacuum chambers, severe chemical environment, power lasers, UV, IR, polarization maintaining devices, etc. Contact: AUBE Hervé, Technical Manager, aube.h@sedi-fibres.com; RANDAZZO Christine, Sales Assistant, randazzo.c@sedi-fibres.com.



The "4POWER" connector, designed for very high power Laser delivery systems.

SEMELAB PLC

#109

Coventry Road, Lutterworth, Leicestershire, United Kingdom, LE17 4JB
+44 1455 552505; fax +44 1455 552512
sales@semelab.co.uk; www.semelab.com

New Product: PhotoASICs, Photodiodes, Hybrid Emitters/ Detectors, Smoke Detector ASICs, Light Monitoring.

The Semelab Group has been a leading provider of high-end, innovative electronic solutions since 1974. We have our own ISO 9000 approved wafer fab in Glenrothes, Scotland called Semefab, and all aspects of design, processing, testing, packaging and qualification take place within the Semelab Group, thereby ensuring complete control over quality and reliability. Approvals: ISO, ESA, DSCC and CECC amongst many others. Contact: Steve Bishton, Semelab Opto Divisional Manager, sbishton@semelab.co.uk; Peter Gorniak, Semefab Sales Marketing Executive, peter.gorniak@semefab.co.uk.

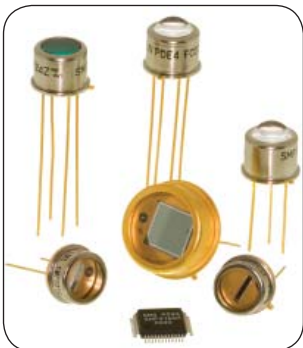

Wide range of Opto Photodiodes, Hybrid Detectors, Emitters & PhotoASICs.

Sill Optics GmbH & Co., KG

#221

SPIE Corporate Member

PO Box 1127, Wendelstein, Germany, 90530
49 9129 90230; fax 49 9129 9023 23
info@silloptics.de; www.silloptics.com

New Product: Laser Optics, CCD Lenses, Telecentric Lenses, Illumination.

Sill Optics develops and manufactures a wide range of Telecentric lenses, Illumination Systems, CCD-Lenses with C-mounts, either of the shelf or customized manufactured. Scanlenses for Printing, Beamexpanders, Yag Focussing Optics, Profile Projector Lenses are in the program including custom made Optical Systems and components for Prototypes and series. Contact: Konrad Hentschel, Research and Quality Assurance Manager, konrad.hentschel@silloptics.de; Markus Klahr, Sales Manager, markus.klahr@silloptic.de.



Laser Optics for femto second lasers.

SIOF-Italian Society of Optics and Photonics

#516

Via Panciatichi 64, Firenze, Italy, I-50127
39 055 4235214; fax 39 055 4235352
siof@ifac.cnr.it;

Space Light srl

#518

Viale Combattenti Alleati d'Europa 9/G, Borsea - Rovigo, Italia, Italy, 45030
+39 0425 471055; fax +39 0425 471095
www.spacelight.it

Space Light SRL is an Italian SME involved in the realization of custom optical systems. Space Light is specialized in the application of adaptive optics techniques and technologies in various fields, including free space optical communications, intra-cavity wavefront control, laser beam size control. www.spacelight.it. Contact: Massimiliano Tordi, Chief Technical Officer, massimiliano.tordi@spacelight.it.

Spectroscopy Magazine

#433

Advanstar Communications, Bldg F 1st Fl 485 Route 1 South, Iselin, NJ, 08830
732/596-0276; fax 732/596-0003
spectroscopyedit@advanstar.com; www.spectroscopyonline.com
Spectroscopy, with an audited circulation of 24,300, is the only publication dedicated exclusively to the spectroscopic sciences, providing peer-reviewed technical and applications-oriented information to the largest audited circulation of influential spectroscopists in the United States. Contact: Jim Colford, East Coast Sales Representative, jcolford@advanstar.com; Ed Fantuzzi, Publisher, efantuzzi@advanstar.com.

Exhibition Directory

SphereOptics GmbH

#504

Bergstrasse 36, Uhdlingen, Germany, D 88690
+49 7556 9299666; fax +49556 5108
sphereoptics@t-online.de; www.sphereoptics.com

New Product: Homogeneous Light Source, interior housing made out of Zenith highly diffuse reflectance material.

SphereOptics serves the market with a wide range of Integrating Spheres, Systems and components for the characterization of light, Materials and Standards for diffuse reflectance and calibration services. We offer custom solutions and develop, together with the customer, systems to meet their application needs. The SphereOptics facility in Germany is also specialized on the production, optimization and calibration of lambertian materials and standards for diffuse transmission and reflectance. Contact: Christina Böhme, Business Development, cboehme@sphereoptics.com; Wolfgang Böhme, General Manager, wboehme@sphereoptics.com.



The Integrating spheres SphereOptics offers have a highly diffuse reflectance interior and are used to calibrate cameras, CCD and CMOS Chips and to measure lamps.

Spiricon GmbH

#419

SPiE Corporate Member

An der Strusbek 60-62, Ahrensburg, Germany, D-22926
+49-(0)4102-6671802; fax +49-(0)4102-6671803
sales@spiricon.com; www.spiricon.de

New Product: Fast high resolution Laser Beam Analyser systems; fast, precise, ISO compatible M2 measurement.

Spiricon GmbH, member of the OPHIR Group, the leading manufacturer of laser beam measurement and analysis instruments is the European subsidiary for all of the group's beam analysis systems. All systems are truly based on the related ISO recommendations for M2 measurement and beam diagnostics. All system feature the patented "UltraCal" method of CCD chip calibration. Spiricon GmbH sells directly to European customers in order to provide the best possible local service. Contact: Juergen Reingruber, General Manager, reingruberj@spiricon.de.



All-new M2-200S system, fast, precise and fully ISO compatible.

Springer

#211

Tiergartenstr 17, Heidelberg, Germany, 69121
+49(0) 6221487-0; fax +49(0) 6221487-8366
www.springer.com

Find your book or journal in *Optics and Photonics* at Springer! Benefit from the 20% conference discount at the booth and choose from a wide selection, including the Springer Handbook of Lasers and Optics. Furthermore, see which journals, including Applied Physics B, you can access at springerlink.com. Or discuss your ideas with our Publishing Editor. Contact: Thorsten Schneider, Publishing Editor, thorsten.schneider@springer.com; Fleur van Dijl, Product Manager, fleur.vandijl@springer.com.

Stanford Computer Optics GmbH

#114b

Entenbachstr 14, München, Germany, 81541
49 89 652029; fax 49 89 654817
europe@stanfordcomputeroptics.com;
www.stanfordcomputeroptics.com

Taylor & Francis - Contemporary Physics

#528

Milton Park, 4 Park Square, Abingdon Oxon, United Kingdom, OX14 4RN
44 0207 017 6438; fax 44 0207 017 6714
www.informaworld.com/journals

Taylor & Francis - Fiber and Integrated Optics

#528

Milton Park, 4 Park Square, Abingdon Oxon, United Kingdom, OX14 4RN
44 0207 017 6438; fax 44 0207 017 6714
david.varley@informa.com; www.informaworld.com/journals

Taylor & Francis - Informa UK Ltd.

#528

4 Park Sq, Milton Park, Abingdon Oxfordshire, United Kingdom, OX14 4RN
44 207 017 6419; fax 44 207 017 6715
david.varley@informa.com; www.informaworld.com

Taylor & Francis, founded in the City of London in 1798, is the oldest commercial journals publisher in the world, and one of the leading global academic publishers. We publish over 900 peer-reviewed research journals and around 1,800 new books each year: our backlist is in excess of 20,000 specialist titles. Taylor & Francis is part of the Academic Division of Informa plc. Contact: David Varley, Marketing Executive.

Taylor & Francis - International Journal of Optomechatronics

#528

Milton Park, 4 Park Square, Abingdon Oxon, United Kingdom, OX14 4RN
44 0207 017 6438; fax 44 0207 017 6714
david.varley@informa.com; www.informaworld.com/journals

Taylor & Francis - Journal of Modern Optics

#528

Milton Park, 4 Park Square, Abingdon Oxon, United Kingdom, OX14 4RN
44 0207 017 6438; fax 44 0207 017 6714
www.informaworld.com/journals

THALES Laser

#506

Domaine de Corbeville - RD 128, Orsay Cedex, France, F-91401
33 1 69 33 06 94; fax 33 1 69 33 02 71
thales-laser@fr.thalesgroup.com; www.thales-laser.com

New Product: ETNA HP 4kHz/30kHz; 75W to 150W @532 nm and 80W to 200W@1064 nm; M² from 1.2 to 20.

Nanosecond and femtosecond lasers, ultrafast solid-state pulsed lasers, turnkey systems and custom solutions are the core business and expertise of Thales Laser. The quality and stability of its products meet the needs of both industrial and scientific applications. Visit our website: www.thales-laser.com. Contact: Ghez Fabien, Sales Engineer, Products and Systems, fabien.guez@fr.thalesgroup.com; Andreani Ariane, Sales Manager, Products and Systems.



Nd:Yag Laser - High Power - High Repetition Rate - Gaussian Profile.

The Institution of Engineering and Technology (IET)

#425

Michale Faraday House, Six Hills Way, Stevenage, Hertfordshire, United Kingdom, SG1 2AY
+44 1438 765520; fax +44 1438 767317
hdyball@theiet.org; www.theiet.org

The IET is one of the world's leading professional societies for the engineering and technology community with more than 150,000 members in 127 countries. A strong publishing division produces a suite of high-quality peer reviewed journals including Electronics Letters, a world-renowned rapid publication encompassing the entire spectrum of electronic and electrical engineering. Read about the very latest photonics research by picking up a free sample copy or sign up for a free online trial. Contact: Helen Dyball, Managing Editor, hdyball@theiet.org.



Published by the IET - high quality journals for the latest photonics research.

Thorlabs GmbH

#517

Hans-Boeckler-Str.6, Dachau, Munich, Germany, 85221
49 8131 59 56 0; fax 49 8131 59 56 99
europe@thorlabs.com; www.thorlabs.com

New Product: Power and Energy Meters, Wavefront Sensors, Compact Autoalignment and Quadrant Detector Reader Modules.

Thorlabs is a broad based optical technologies company with expertise in design and manufacture of innovative photonics products. The over 11.000 different products comprise optical and opto-mechanical components, tables and vibration control, nanopositioning solutions, test and measurement systems and laser sources. Thorlabs mission is to provide innovative tools with best possible support to its customers in the shortest possible time. Contact: Angelika Kueng, Sales Europe, akueng@thorlabs.com.



New Dual Channel Optical Power & Energy Meter with USB 2.0.

TSP Diffusion

#417

14 Place des Victoires, Asnieres, France, 92600
+33(0)140864150; fax +33(0) 147935013
www.tsp-diffusion.com

New Product: Exclusive distributor of the SPIE Digital Library in France.

TSP founded in 1995 specialized in providing access to scientific databases to the academic, research and corporate world. www.tsp-diffusion.com. For more information, Contact: Cecile Waroquaux, Account Manager, cecile.waroquaux@tsp-diffusion.com; Sylvie Pithoud, Managing Director, sylvie.pithoud@tsp-diffusion.com.



SPIE journals available from TSP Diffusion.

Exhibition Directory

UCM AG

#116

Langenhagstr 25, Rheineck, Switzerland, CH-9424
41 71 886 6760; fax 41 71 886 6761
ucm@ucm-ag.com; www.ucm-ag.com

New Product: Ultrasonic Cleaning Machines with Infrared Dryer especially designed for all optical substrates.

UCM-AG of Switzerland designs and manufactures Ultrasonic Cleaning Machines for high quality needs. The company has a very wide and long experience and very good reputation in the world of optics. The Systems are made for a cleaning prior to vacuum coating and fulfil all requirements for a completely particle-free and spotless, fully activated substrate surface. The systems are customized and are either fully automated or manual. The Cleaning process is designed and guaranteed by UCM. Contact: Hans Ulrich Hofstetter, Sales Manager, h.hofstetter@ucm-ag.com

Unice E-O Services Inc.

#422

Chung Li Industrial Park, 3F No 25-2 Ji Lin Rd Chung Li, Taoyuan, Taiwan, 320
886 3 462 6569; fax 886 3 462 5586
johnnyc@email.unice.com.tw; www.unice.com.tw

New Product: High performance multi-axes alignment parts and system, motorized available.

Unice possess all the necessary resources to offer our customer's solution, from hardware, software design, detecting devices selection and then integrated all of them into an extremely powerful customized system for different application in the lab, production line, QC line and anywhere it has been needed. Contact: Johnny Chang, President, johnnyc@email.unice.com.tw.



Miniature high precision crossed-roller bearing translation stage with lockable function.

Universal Photonics, Inc.

#207

SPIE Corporate Member

495 W John St, Hicksville, NY, 11801-1014
516/935-4000; fax 516/935-4144
info@universalphotonics.com; www.universalphotonics.com

New Product: LP UNALON unique, micro-cellular foam elastomer specifically designed for high precision polishing.

Specializing in developing and formulating lapping/polishing consumables and machinery for glass, plastic, crystals, infrared, semiconductor, electro, laser and fiber optics. Including high precision polishing pads and compounds, ultra-pure alumina, diamond powders and water-based nano-sized alpha alumina diamond slurries, precision optical pitch and new Synthetic Pitch, plus wide assortment of waxes and cements and more. Contact: Dave Keller, Vice President European Operations/Sales, davek@universalphotonics.com; Justin Mahanna, Director Field Application Engineering, justinm@universalphotonics.com.



LP Unalon – Unique microcellular foam elastomer designed for high precision polishing.

VTT Technical Research Centre of Finland #129

Kaitovayla 1, Oulu, Finland 90571
+358 20 722 777; fax +358 20 722 7001
kirjaamo@vtt.fi; www.vtt.fi

VTT is an impartial expert organisation developing technologies, creating innovations and bringing added value to products. With the know how together with global networking, VTT produces R&D services to industry and organisations. VTT promotes the realisation of innovative solutions and growing new businesses. VTT is focusing on the fabrication and integration methods of electronics and optics as well as development of optical instruments. Contact: Pentti Karioja, Research Professor, pentti.karioja@vtt.fi; Mikko Karppinen, Team leader, mikko.karppinen@vtt.fi.

Wiley-VCH GmbH & Co. KGaA

#523

Boschstr 12, Weinheim, Germany, 69469
49 6201 606 555; fax 49 6201 606 100
info@wiley-vch.de; www.wiley-vch.de

Xiton Photonics GmbH

#501

Openstr 10, Kaiserslautern, Germany, 67661
49 631 627 5915; fax 49 176 212 59078
sales@xiton-photonics.com; www.xiton-photonics.com

New Product: XVL-1.06-Q-5HG: Reliable 213nm q-switched high repetition rate q-switched laser with 100mW power.

Xiton Photonics produces high beam quality q-switched kHz repetition rate laser systems for science and industry. Our competence is especially the nonlinear frequency conversion to generate powerful fixed and tunable laser light in the wavelength range between 4, 5µm-200nm. Contact: Juergen Bartschke, Chief Executive Officer.

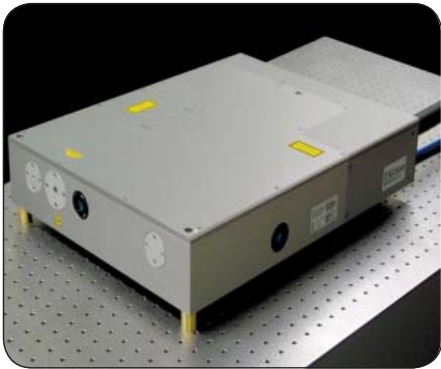

213nm XVL-1.06-Q-5HG. Reliable industry proven DPSS lasers at various wavelengths are offered by Xiton Photonics GmbH, Germany.

XLITH GmbH

#432

Wilhelm Runge Str.11, Ulm, Germany, 89081
+49 731 505 5900; fax +49 731 5055905
info@xlith.com; www.xlith.com

XLITH - Extreme Lithography®; Advanced microelectronics, photonics, nanotechnology, they all rely on high-resolution e-beam lithography as the primary source for ultra-fine lateral patterns, generated directly on the substrate or on transfer media like masks, masters, templates or molds. XLITH serves customers in the field of photonics, advanced RF applications and nanotechnology. We realize patterns in the 10-250nm regime on virtually every substrate up to a diameter of 150mm. Contact: Norbert Käb, Senior Process Engineer, n.kaeb@xlith.com; Bernd Maile, Managing Director, b.e.maile@xlith.com.

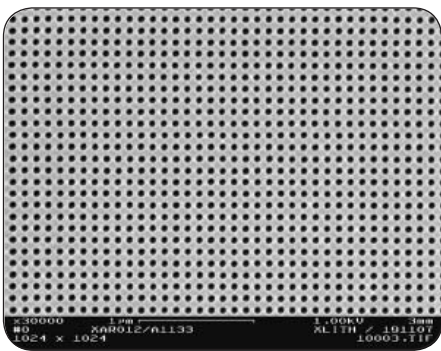

Microscope Calibration Standard with 100nm Dot Pitch.

Yole Développement

#225

45 rue Sainte Genevieve, Lyon, France, 69006
33 472 83 01 82; fax 33 472 83 01 83
info@yole.fr; www.yole.fr

ZODIAC

#322

Route de Nozay, Marcoussis, France, 91460
+33 1 3077 68 93; fax +33 1 3077 67 86

ZODIAC is an EC funded research project aiming at the development of new Quantum Dots nanomaterials for laser diodes and optical amplifier. Well supported by academic partners, ZODIAC integrates a vertical chain of industrial partners to demonstrate both the manufacturability of the new material and its technique. Demonstrators are developed to respond to the needs for low cost, highly reliable components matched to the growing metropolitan telecom market. Contact: Carmen Gonzalez, Programme Manager, carmen.gonzalez@3-5lab.fr; Denis Mazerolle, Business Development Executive, denis.mazerolle@3-5lab.fr.

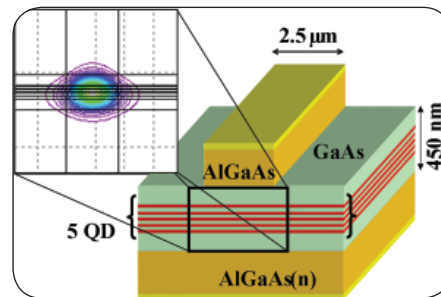

Schematic of Quantum Dot-based waveguide modulator (CNRS/LPN).

SPIE Corporate Members

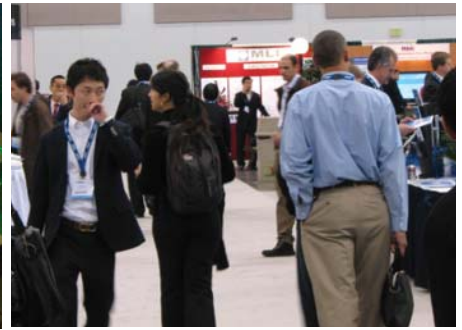
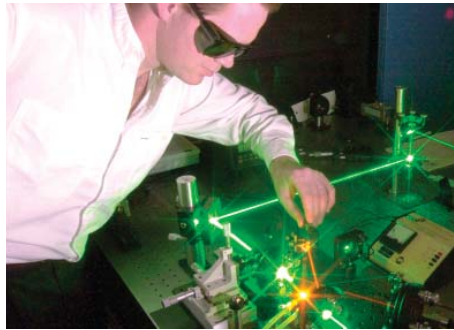

SPIE Corporate Member

Through collaboration, companies large and small steer the latest innovations toward practical relevance in the global marketplace.

SPIE Corporate Membership enhances your organization by providing significant discounts on:

- ▶ SPIE exhibitions*
- ▶ SPIE publications
- ▶ SPIE Digital Library subscriptions
- ▶ Advertising rates
- ▶ Mailing lists
- ▶ Recruitment services

*Corporate Members receive a 15% discount on exhibit space at events solely owned by SPIE.

Left/Middle Cover Photo Courtesy of SCHOTT. (Left photo: Fiber optical light guides. Drawing makes fiber optical light guides wafer-thin; Right photo: LED in flat glass. Light Points are LED's in a PVB flat glass foil laminate can be used in interiors, as glass walkways, as construction components for doors and many other products. Right Cover Photo Courtesy of Stephen Ausmus. Renewable-energy team members prepare experimental wind turbine blades for atmospheric testing. Team members pictured are ARS agricultural engineers Byron Neal (left foreground) and Nolan Clark (right foreground), and, from Sandia National Laboratories, electrical engineer Mark Rumsey and technician Donny Cagle (background).

SPIE.org

Corporate members as of
11 February 2008

3DIcon Corp.
4D Technology Corp.
A&I Ltd.
A*STAR Institute for Infocomm Research/A*STR/Kent Ridge
ABET Technologies, Inc.
Aculight Corp.
Adimec Electronic Imaging, Inc./North America
Advanced Optowave Corp.
Aerotech, Inc./World Headquarters
AF Optical Inc.
AFL Telecommunications LLC/Corporate
AgilOptics, Inc.
Alfalight, Inc.
ALIO Industries
Alphion Corp.
Alpine Research Optics Corp./Headquarters
Alson E. Hatheway, Inc.
Altos Photonics, Inc.
Ampex Data Systems Corp.
Amplitude Laser
Andor Technology plc/North American Office
Apollo Instruments, Inc.
Applied Image, Inc./Imaging Division
Applied Photonics, Inc.
Archer OpTx, Inc.
Arden Photonics Ltd.
Arroyo Instruments
Asahi Spectra USA Inc.
ASD Inc.
ASML US, Inc.
asphericon GmbH
Avantes, Inc./Avantes USA
Avo Photonics, Inc.
Axsys Technologies, Inc./Imaging Systems
Ayase America Inc.
AZ Electronic Materials USA Corp./USA Corp.
Azure Photonics Co.
B&W Tek, Inc.
Barr Associates, Inc.
BaySpec, Inc.
Beamtech Optronics Co. Ltd.
Berliner Glas U.S.
Blue Ridge Optics LLC
Boston Applied Technologies, Inc.
Boston Micromachines Corp.

Breault Research Organization, Inc.
Brewer Science, Inc./North America Headquarters
Brighten Optics Ltd.
Bristol Instruments, Inc.
Cabot Microelectronics Corp.
Cadence Design Systems, Inc./DFM Division
Calmar Optcom Inc.
Cambridge Research & Instrumentation, Inc./Headquarters
Cambridge Technology, Inc.
Canon U.S.A., Inc./Semiconductor Equipment Div
Carl Zeiss, Inc./Camera Lens Div.
Cascade Optical Corp.
Cascade Technologies Ltd.
Central Electronics Engineering Research Institute/CEERI Ctr
Central Research Institute Cyclone
CeramOptec Industries, Inc./biolitec Div/USA
China Daheng Group, Inc.
Chroma Technology Corp.
Chroma Technology GmbH
CI Systems, Inc./California Office/Simi Valley
Coastal Optical Systems, Inc./Production/Shop
Coherent, Inc./Corporate Headquarters
College of Optical Sciences/The Univ. of Arizona
Continuum, Inc.
Contrast Optical Design & Engineering, Inc.
CorActive High-Tech Inc.
Cristal Laser S.A.
Crystalaser
Cyantek Corp.
DataRay Inc.
Davidson Optronics Inc.
Del Mar Photonics, Inc.
Deposition Sciences, Inc.
Diemat, Inc.
Digilab, Inc./Spectroscopy Div
DILAS Inc.
Directed Perception, Inc.
Docter Optics Inc.
Dongjin Semichem Co., Ltd./Electronic Materials Div
dopa Diamond Tools
DRS Technologies, Inc.
Dyna Technologies, Inc.
Edmund Optics Inc./Main Office
EKSPLA UAB

Electro-Optical Imaging, Inc.
Elite Engineering Corp.
Elliot Scientific Ltd.
EM4, Inc.
Engineering Synthesis Design, Inc.
ET Precision Optics Inc.
Even Systems
Excell Technology
Fairfield Crystal Technology, LLC
Femtochrome Research, Inc.
FemtoLasers, Inc.
Fiberguide Industries, Inc.
Fibertech Optica, Inc.
Fibre Photonics Ltd.
Firebird Technologies Inc.
Flexible Optical B.V.
FLIR Systems, Inc./Boston Division
FOCtek Photonics, Inc.
Foreal Spectrum, Inc.
Frankfurt Laser Co.
Fresnel Technologies Inc.
GE Fanuc Intelligent Platforms
General Atomics/Photonics Div
Gentec Electro-Optics Inc.
Gist Optics Co., Ltd.
Glass Fab, Inc.
Goodrich Corp./Optical & Space Systems Div
Grintech GmbH
G-S PLASTIC OPTICS/A Germanow-Simon Co.
GSI Group Inc./Corporate Office-Mfg. Ctr.
Gudeng Precision Industrial Co., Ltd.
Halbo Optics Ltd.
Hamamatsu Corp.
Hangzhou Yongying Optics & Electronic Co., Ltd.
Hardin Optical Co.
Headwall Photonics Inc.
Heidelberg Instruments Inc./Service USA
Hellma USA, Inc.
High Plains Optics, Inc.
Hinds Instruments, Inc.
Hitachi High Technologies America, Inc./Electron Microscope Div. Headquarters
HOLOEYE Photonics AG
HORIBA Jobin Yvon Inc./OEM Div
Image Engineering
Imperx Inc.
IMPEX High-Tech GmbH
IMRA America, Inc./Headquarters & Research Facility

SPIE Corporate Members

- Incom Inc.
 Infinite Optics Inc.
 INGENERIC GmbH
 Inlight Precision Optics Co., Ltd.
 Innolume GmbH
 Innovations in Optics, Inc.
 Integrated Optoelectronics A/S
 International Radiation Detectors, Inc.
 Intevac, Inc.
 IO Industries, Inc.
 IR Photonics
 Isomet Corp.
 Isuzu Glass, Inc.
 JDSU/Corporate Headquarters
 JENOPTIK Laser, Optik, Systeme GmbH/Business Unit Optics
 JSR Micro, Inc.
 Judson Technologies LLC
 KLASTECH-Karpushko Laser Technologies GmbH
 KLA-Tencor Corp.
 Kugler of America Ltd.
 L-3 Communications Cincinnati Electronics
 Labsphere, Inc./Eastern Regional Sales
 Lambda Research Corp.
 Lambda Research Optics, Inc./Lasers Optics & Coatings
 Laser Components IG, Inc.
 Laser Diode Array, Inc.
 Laser Focus World/Pennwell
 Laser Optics
 Lasertec USA Inc.
 Lasertel Beijing
 Lasertel, Inc.
 Lattice Electro Optics, Inc.
 Leister Technologies LLC
 Leybold Optics USA, Inc.
 Light Logics Holography and Optics PVT Ltd.
 LightWorks Optics, Inc.
 Lincoln Laser Co.
 Liquidia Technologies, Inc.
 Lovelite
 LT Ultra Precision Optics, LLC
 Lucid Dimensions
 Mad City Labs., Inc.
 Market Tech, Inc.
 Martin Professional A/S
 Max Levy Autograph, Inc.
 Mechanical Engineering Professionals LLC
 Mempile - Israel, Ltd.
 MEMS Optical, Inc.
 Mentor Graphics Corp./Design to Silicon
 Metavac LLC
 Metrology Concepts LLC
 MICOS USA
 Micro Care Corp.
 Micronic Laser Systems AB
 MicroSecurity Lab Inc.
 Mildex, Inc.
 Mindrum Precision, Inc.
 Minus K Technology Inc.
 MLD Technologies, LLC
 Model Optics, Inc.
 MPA Crystal Corp.
 MPB Communications Inc.
 n&k Technology, Inc.
- NANO-UV
 National Aperture, Inc.
 New Focus, Inc.
 New Mexico Optics Industry Association
 New Scale Technologies, Inc./Main Office
 Nikon Corp./HQ for Nikon Corp
 Nikon Precision Inc.
 Nivo Technology
 nLight Corp./Corporate Headquarters
 Norland Products Inc.
 North Crystals America
 Nufern
 NuFlare Technology, Inc./Yokohama Satellite Office
 Observatorio Astronomico Nacional
 Ocean Optics, Inc.
 Oerlikon Optics USA Inc./Unaxis Optics Division
 OFS/Specialty Photonics Div
 Obara Corp./Eastern Office
 Omega Optical, Inc./Corporate Office
 Ondax, Inc.
 OneLight Corp.
 Ontar Corp.
 Ophir Optronics, Inc.
 Opnext, Inc.
 Optec S.p.A.
 Op-Test
 Opti Temp, Inc.
 Optical Filter Source, LLC
 Optical Research Associates
 Optical Support, Inc.
 OPTICS 1, Inc./Commercial Systems Div.
 Optics for Hire
 Optikos Corp.
 Optimax Systems, Inc.
 OptiPro Systems/Div. of VI Manufacturing, Inc.
 OptiSource, LLC
 Opto Diode Corp.
 OptoElectronic Components
 Optonetic LLC
 OSRAM Opto Semiconductors Inc.
 OZ Optics Ltd.
 Pacific Coast Optics
 PFG Optics
 Photon Design
 Photon Engineering, LLC
 Photonics Industries International, Inc.
 Photon USA, Inc.
 PI (Physik Instrumente) L.P.
 Piezosystem Jena Inc.
 PLANSEE Thermal Management Solutions
 PLX Inc.
 Poco Graphite, Inc.
 Point Source Ltd.
 Polymicro Technologies, A Subsidiary of Molex
 Povolzhskaya State Academy of Telecommunications and Informatics
 Power Technology, Inc.
 Precision Asphere LLC
- Precision Glass & Optics
 Precitech, Inc.
 Princeton Instruments
 Process Materials Inc.
 QED Technologies, Inc./Corporate Headquarters
 Qioptiq Ltd.
 QPC Lasers, Inc.
 Quantel USA/North American Headquarters
 RAVE LLC
 Raydiance, Inc.
 RBIT a Non-Profit Partnership
 Redondo Optics, Inc.
 RedShift Systems Corp.
 Research Electro-Optics, Inc.
 Reynard Corp.
 Ricmar Sales & Service GmbH
 Riegl USA Inc.
 Rockwell Laser Industries, Inc.
 Rocky Mountain Instrument Co./Laser Div
 Rolyn Optics Co.
 RPC Photonics, Inc.
 RSoft Design Group, Inc.
 Sacher Lasertechnik GmbH
 Salem Distributing Co./Precision Div.
 Salvador Imaging, Inc.
 Satisloh North America Inc./Precision Optics
 SCANLAB America, Inc.
 Schneider Optics, Inc./Industrial Optics Div
 SCHOTT North America, Inc./Optics for Devices
 Scientific Solutions, Inc.
 SensL
 Sensors Unlimited, Inc., part of Goodrich Corp.
 Servometer - PMG LLC
 SGS Slicing Solutions Inc.
 Shanghai Optics
 Sheumann Inc.
 Showmark LLC
 Sigmameltec Ltd.
 Sill Optics GmbH & Co., KG
 SMA Optical Technologies, Inc.
 Special Optics Manufacture and Design, Inc.
 Specim Spectral Imaging Ltd.
 Spectrogon AB/Headquarters-Sweden
 Spectrogon UK Ltd.
 Spectrum Detector, Inc.
 SphereOptics, LLC
 Stanford Computer Optics Inc.
 Star Tech Instruments
 StellarNet, Inc.
 Step Development
 StockerYale, Inc.
 Surmet Precision Optics
 Syntec Optics
 Taboada Research Instruments, Inc.
 Techmetals, Inc./Optics Div.
 TecOptics, Inc.
 Tecport Optics Inc.
 Telops, Inc.
 Tessera North America
- Tessera, Inc.
 TFI Telemark
 TGT Optoelectronic Technology Co.
 The Cooke Corp.
 Thermo Fisher Scientific Inc./CIDTEC Cameras & Imagers
 Thorlabs, Inc.
 Toppan Photomasks, Inc./Headquarters for Toppan Photomasks, Inc.
 Toptica Photonics, Inc.
 Tower Optical Corp.
 Translume, Inc.
 Trex Advanced Materials/Materials
 Trioptics GmbH
 TRUMPF Inc.
 Tydex JS Co.
 Umicore Thin Film Products
 Union Optic, Inc.
 Univ. of Iowa Libraries
 Univ. of New Mexico/Ctr for High Technology
 Universal Photonics Inc.
 Ural Optical and Mechanical Plant
 Vavilov State Optical Institute/All-Russian Research Ctr.
 Veeco Instruments
 Veeco Ion Beam Equipment Inc.
 Veeco Metrology Inc./AFMs
 Veeco Metrology Inc./Optical Profilers
 Verrillon Inc.
 VueMetrix
 Wavelength Electronics, Inc.
 Westchester Technologies, Inc.
 Western Photonics Technology
 Wordingham Technologies
 World Star Technologies
 WZW-Optic AG
 XenICs NV
 Xi'an Huanic Optoelectronic Corp. Ltd.
 XYALIS
 Y&M Technologies, Inc.
 Yield Engineering Systems Inc.
 Zhejiang Dali Technology Co., Ltd.
 Z-Laser Optoelektronik GmbH
 Zomega Terahertz Corp.
 Zygo Corp.

Product Categories

Abrasives, Chemicals & Process Materials

NEYCO
Thales Laser
Universal Photonics, Inc.

Astronomy

Epner Technology, Inc.
Flexible Optical BV
FRAMOS GmbH
Frank Optic Products GmbH
OpTIC
OptiGrate
Photonic Cleaning Technologies
Spacelight SRL
SphereOptics GmbH
Springer

Cameras and CCD Components

FRAMOS GmbH
Hamamatsu
Kimoga Material Technology Co., Ltd.
Optronis GmbH
Photonic Cleaning Technologies
SphereOptics GmbH
Spiricon GmbH

Clinical, Chemical and Biological Instrumentation

Fibertech Optica

Communications

DRAKA
Fraunhofer Heinrich Hertz Institut
International Society for Stereology
OptiGrate
RSoft Design Group
Spectroscopy Magazine

Displays

Breault Research Organization
Fraunhofer Heinrich Hertz Institut
OpTIC

Distributor or Reseller

AHF analysentechnik AG
FRAMOS GmbH
GWU-Lasertechnik GmbH
Opton Laser International
TSP Diffusion

Electron-Beam Lithography

XLITH GmbH

Electronic Imaging Components, Equipment, Systems

SEMELAB PLC

Fiber Optic Components, Equipment, Systems

Avantes
Crystal Fibre
DRAKA
Frank Optic Products GmbH
iXFiber
LINOS Photonics France
Lovalite
Newport Spectra-Physics
Ocean Optics
Santec Europe Ltd.
Sill Optics GmbH & Co., KG
Thorlabs GmbH
Unice E-O Services Inc.

Finished Optics, Filters, & Coatings, Optical Fabrication Equipment

AHF analysentechnik AG
CVI Melles Griot Ltd.
EKSPLO Co.
Epner Technology, Inc.
KERDRY
Kimoga Material Technology Co., Ltd.
Laser Zentrum Hannover e.V. (LZH)
LINOS Photonics France
Omega Optical, Inc.
OptiGrate
SEMELAB PLC

High Speed Imaging and Sensing

Hamamatsu
International Society for Stereology
Optronis GmbH
Santec Europe Ltd.
Scientec

Illumination Engineering

Sill Optics GmbH & Co., KG

Infrared Sources, Detectors, Systems

Alcatel Thales III V Lab
EPIC: European Photonics Industry Consortium
Epner Technology, Inc.
ET Enterprises Ltd
Fraunhofer Heinrich Hertz Institut
id Quantique SA
Institut d'Optique Graduate School
Laser Components GmbH
SphereOptics GmbH
ZODIAC

Lasers and Other Light Sources, Laser Accessories, Laser Systems

AHF analysentechnik AG
Alcatel Thales III V Lab
Crystal Fibre
CVI Melles Griot Ltd.
EKSPLO Co.
EPIC: European Photonics Industry Consortium
Frank Optic Products GmbH
Fraunhofer Heinrich Hertz Institut
Gorman Rupp Industries
GWU-Lasertechnik GmbH
id Quantique SA
IMPEX HighTech
Institut d'Optique Graduate School
iXFiber
KLASTECH
Laser Components GmbH
Laser Zentrum Hannover e.V. (LZH)
Menlo Systems GmbH
MICOS GmbH
Newport Spectra-Physics
NP Photonics
OpTIC
Opton Laser International
OXXIUS
Quantel
Raicol Crystals Ltd.
Santec Europe Ltd.
SEMELAB PLC
Sill Optics GmbH & Co., KG
Thales Laser
Xiton Photonics GmbH
XLITH GmbH
ZODIAC

Law Enforcement Technologies

Photonic Cleaning Technologies

Life Sciences

AHF analysentechnik AG
ET Enterprises Ltd
Frank Optic Products GmbH
International Society for Stereology
Optronis GmbH
Royal Society of Chemistry
Spacelight SRL

Metrology, Inspection and Process Control

Fibertech Optica
Flexible Optical BV
IMPEX HighTech
Institut d'Optique Graduate School
Lovalite
Menlo Systems GmbH
Ocean Optics
Scientec
Spacelight SRL

Nanotechnology

CEDRAT Technologies
CEIT
ePIXnet
Laser Zentrum Hannover e.V. (LZH)
NEYCO
Photonic Cleaning Technologies
Quantel
Royal Society of Chemistry
RSoft Design Group
RSP Technology BV
Scientec
Springer
XLITH GmbH

Non-Optical Lithography

XLITH GmbH

Optical Components

AHF analysentechnik AG
Conerefringent Optics SL
Crystal Fibre
CVI Melles Griot Ltd.
EKSPLO Co.
EPIC: European Photonics Industry Consortium
ePIXnet
Epner Technology, Inc.
ET Enterprises Ltd
Flexible Optical BV
FRAMOS GmbH
Frank Optic Products GmbH
Fraunhofer Heinrich Hertz Institut
Fujian CASTECH Crystals, Inc.
GWU-Lasertechnik GmbH
HC Photonics Corp
IMPEX HighTech
iXFiber
Kimoga Material Technology Co., Ltd.
Laser Components GmbH
Laser Zentrum Hannover e.V. (LZH)
LEONI Fiber Optics GmbH
LINOS Photonics France
Lovalite
Newport Spectra-Physics
Omega Optical, Inc.
OpTIC
OptiGrate
Opton Laser International
Raicol Crystals Ltd.
Santec Europe Ltd.
SEMELAB PLC
Sill Optics GmbH & Co., KG
Thorlabs GmbH
Unice E-O Services Inc.

Optical Detectors

ET Enterprises Ltd
Hamamatsu
id Quantique SA
Institut d'Optique Graduate School
Menlo Systems GmbH
Newport Spectra-Physics
Ocean Optics
RSoft Design Group
SEMELAB PLC
Spiricon GmbH

Optical Fibers

Crystal Fibre
DRAKA
Fibercore Ltd.
Fibertech Optica
iXFiber
Laser Components GmbH
LEONI Fiber Optics GmbH
Ocean Optics
Sill Optics GmbH & Co., KG
Springer
Thorlabs GmbH

Optical Materials and Substrates

Alcatel Thales III V Lab
Brush Ceramic Products
CVI Melles Griot Ltd.
EKSPLO Co.
EPIC: European Photonics Industry Consortium
Fujian CASTECH Crystals, Inc.
GWU-Lasertechnik GmbH
HC Photonics Corp
Kimoga Material Technology Co., Ltd.
NEYCO
Raicol Crystals Ltd.
RSoft Design Group
RSP Technology BV
SphereOptics GmbH
Springer

Optical Test and Measurement Equipment, Interferometer

Avantes
Flexible Optical BV
Institut d'Optique Graduate School
MICOS GmbH
Opton Laser International
Optronis GmbH
Santec Europe Ltd.
Scientec
Spiricon GmbH
Thales Laser
Thorlabs GmbH
Unice E-O Services Inc.

Optical/Laser Microlithography

CEIT
IMPEX HighTech
Laser Zentrum Hannover e.V. (LZH)
Lovalite
Quantel
Xiton Photonics GmbH

Optics Manufacturing

Breault Research Organization
CVI Melles Griot Ltd.
EKSPLO Co.
ePIXnet
Fujian CASTECH Crystals, Inc.
IMPEX HighTech
Kimoga Material Technology Co., Ltd.
Laser Components GmbH
LINOS Photonics France
Omega Optical, Inc.
OpTIC
OptiGrate

Photonics Equipment Manufacturer

Breault Research Organization
LINOS Photonics France
MICOS GmbH
Ocean Optics
Raicol Crystals Ltd.
Unice E-O Services Inc.

Positioning Equipment

CEDRAT Technologies
MICOS GmbH
Newport Spectra-Physics
Opton Laser International
Scientec
Thorlabs GmbH
Unice E-O Services Inc.

Resist Technology and Processing

XLITH GmbH

Sensor & Sensor Systems

Avantes
EPIC: European Photonics Industry Consortium
ET Enterprises Ltd
Flexible Optical BV
FRAMOS GmbH
Hamamatsu
id Quantique SA
iXFiber
LEONI Fiber Optics GmbH
SphereOptics GmbH

Services and Publications (Including Professional Societies)

AT-Fachverlag GmbH
Breault Research Organization
Electro Optics Magazine
ePIXnet
EuroPhotonics
International Society for Stereology
Materials Today
Messe Stuttgart
Nature Publishing Group
Optics & Laser Europe
OptoIndex
Royal Society of Chemistry
Taylor & Francis - Informa UK Ltd.
TSP Diffusion

Software

Breault Research Organization
CEDRAT Technologies
International Society for Stereology
Lovalite
Photon Design
RSoft Design Group

Solar and Alternative Energy

Brush Ceramic Products
Gorman Rupp Industries
Royal Society of Chemistry

Vacuum, Cooling, Gas Handling Equipment

MICOS GmbH
NEYCO



People.
Products.
Jobs.



SPIEWorks.com

A service of SPIE

Abstracts Academic Access Alerts Archival Astronomy
Authoritative Availability BibTeX Biomedical Optics
Bookmarking Citation Collaboration Collections
Communications Connected CrossRef Defense
Displays e-First Electronic Imaging EndNote
Engineering Experts Fast Findability Global Google
Scholar Illumination Impact Factor Industry Innovation
INSPEC Interdisciplinary Intuitive IP Journals
Lasers Letters Medical Imaging Medline MEMS
Metrology Microlithography MOEMS Multimedia
MySPIE Nanotechnology Networking Not-for-Profit
Optics Optoelectronics Photonics West Portico
Prior Art Publish Refereed Reference Linking
RefWorks Relevance Remote Sensing RSS
Scitation Scitopia.org Searchability Seminal Sensors
Signal Processing Solar Energy Technology
Transfer Timeliness Tools Trends Vetted Yahoo!

Your trusted source for the
science and application of light

SPIE 
Digital Library

SPIDigitalLibrary.org

**CVI MELLES GRIOT. YOUR SOURCE FOR
BUILD-YOUR-OWN, RAPID DELIVERY SOLUTIONS.**



CVI Melles Griot offers two-week delivery of optics at catalog prices.

- 4000 uncoated substrates
- 2500 coating options
- A wide variety of in-stock substrates available (curves, flats, prisms, waveplates)
- Coatings from 193 nm to 2300 nm
- Your order ships in two weeks or less

How can we help you make your project a success?

